



# **M1 SEGMENT AND SSA INTEGRATION PROCEDURE**

TMT.OPT.TEC.19.013.DRF02

7/9/2019



## DOCUMENT APPROVAL

### Author Release Note:

See Document Change Record for changes.

This procedure will provide guidance and process control for partner integration of PMAs.

### Prepared By:

(signature on file)

---

Glen Cole  
TIO-TMT Lead Optical Fabrication  
Engineer

### Concurrence:

(signature on file)

---

Ben Gallagher  
TIO-TMT M1 Optics Lead Engineer  
TIO-TMT M1 Work Package  
Manager

(signature on file)

---

Eric Hansen  
TIO-TMT Optics Group Lead

(signature on file)

---

John Rogers

(signature on file)

---

Robert Anderson



TIO-TMT M1 Senior Systems  
Engineer

TIO-TMT Quality Manager

**DOCUMENT CHANGE RECORD**

<b>Revision</b>	<b>Change Approval</b>	<b>Release Approval</b>	<b>Date Released</b>
REL01	Initial REL Release	Signatures on file Docushare Routing #XXXXXX	XX XXX 2019

## TABLE OF CONTENTS

<b><u>1. INTRODUCTION</u></b>	<b><u>9</u></b>
1.1 Purpose .....	9
1.2 Scope .....	9
1.3 Applicable Documents .....	9
1.4 Reference Documents.....	9
1.5 Abbreviations .....	9
<b><u>2. OVERALL DESCRIPTION</u></b>	<b><u>11</u></b>
2.1 Integration .....	11
2.2 Integration Personnel.....	12
<b><u>3. INTEGRATION PROCEDURE</u></b>	<b><u>13</u></b>
3.1 Important – segment types.....	13
3.2 Mirror Assemblies .....	13
3.2.1 Bonded Mirror Assemblies.....	13
3.2.2 Dummy Aluminum Segments .....	14
3.3 Safety.....	14
3.3.1 General safety measures .....	14
3.3.2 Work Permits.....	15
3.3.3 Personal Protective Equipment (PPE) .....	15
3.4 Required hardware.....	15
3.5 Personnel .....	17
3.6 Required tooling .....	17
3.7 Loading the segment.....	21
3.7.1 Lift the mirror segment.....	22
3.7.2 Load the segment on the integration table.....	23
3.7.3 Place the segment edges against the fixed pads.....	24
3.8 Check the boss depth of the central diaphragm .....	25
3.8.1 Measure the central diaphragm boss depth.....	26
3.9 Prepare the integration table .....	28
3.10 Preparing to Lift SSA .....	31
3.10.1 Attach the dial indicator assemblies .....	31

3.10.2	Attach the three lifting bars .....	33
3.10.3	Attach the three-arm spreader bar .....	34
3.10.4	Prepare the LVDT .....	35
3.10.5	Lift the SSA out of the SSA stand.....	38
3.10.6	Lower the SSA into the integration table .....	39
3.10.7	Record the dial indicator numbers.....	47
3.10.8	Read the LDVT and record as ‘Dimension B’ .....	48
3.10.9	Calculate the central diaphragm shim value.....	48
3.10.10	Raising the SSA off the integration table .....	48
3.10.11	Pressing the center boss into the moving frame hub .....	50
3.10.12	Level the SSA assembly table .....	52
3.10.13	Fitting central diaphragm hardware.....	54
3.10.14	Install the mirror rod flexures.....	55
3.10.15	Prepare to load the SSA onto the segment .....	60
3.10.16	Level the integration table .....	62
3.10.17	Lower the SSA onto the segment .....	64
3.10.18	Prepare to connect the SSA to the BMA .....	74
3.10.19	Connect the SSA.....	75
3.10.20	Functional Test of the Warping Harness Actuators.....	76
3.10.21	Attach Segment Compensation Weights to the SSA.....	76
3.10.22	Stake the mirror rod flexures .....	76
3.10.23	Install the tangent restraint on the Y arm of the moving frame.....	77
3.10.24	Finish integration.....	80
3.11	Set the tower clocking .....	82
3.12	Measure Assembly with CMM or Roamer Arm .....	91

## TABLE OF FIGURES

Figure 1 – PMA integration.....	11
Figure 2 – Integration operations. ....	12
Figure 3 – The integration table prior to being finally positioned.....	22
Figure 4 – Craning an aluminum dummy segment. The S2 surface is uppermost.....	23
Figure 5 – Correct orientation of the segment on the integration table. ....	24
Figure 6 – Place the segment on the integration table so that is touching the three fixed circular pads as shown. ....	25

Figure 7 – Correct placement of the parallel bar across the top of the central diaphragm. ....	26
Figure 8 – Measure the vertical distance from the top of the parallel bar to the top of the central boss of the central diaphragm. ....	27
Figure 9 – Integration table slides ‘in the B position’. ....	29
Figure 10 – A Delrin ball in a segment datum cone. ....	30
Figure 11 – The alignment posts are not in place yet. ....	31
Figure 12 – A dial indicator assembly is shown here with one of the three lifting bars. ....	33
Figure 13 – Lifting equipment in place, ready to lift the SSA. ....	35
Figure 14 – The LVDT in its holder, with a 75mm green extension straw attached. ....	36
Figure 15 – The Heidenhain ND 287 Display Unit used to read the LVDT. ....	36
Figure 16 – Placing the shim on the central diaphragm. ....	38
Figure 17 – Lowering the SSA for shim measurement. ....	39
Figure 18 – Guide rods in place. ....	40
Figure 19 – The LVDT and its holder resting on moving frame. ....	41
Figure 20 – Placing the LVDT and its holder in place prior to shim measurement. ....	42
Figure 21 – The LVDT probe tip extended below the moving frame hub. ....	43
Figure 22 – Lowering the SSA towards the segment for shim measurement. ....	44
Figure 23 – The vee foot with the white ball receiver removed. ....	45
Figure 24 – The measurement regions (blue circles) to confirm the distance between the S2 surface and the datum surface on the back side of the moving frame arms. ....	47
Figure 25 – The SSA assembly table ....	50
Figure 26 – The center boss as it is pressed into the moving frame hub. ....	51
Figure 27 – The T-handle Allen wrench from the top view, while the center boss is pressed into the hub. ....	52
Figure 28 – Level the integration table using lifting jacks under the legs as necessary. ....	52
Figure 29 – Adjust the level of the integration table using the floor jacks. ....	53
Figure 30 – Check the level of the table with a circular bubble level. ....	53
Figure 31 – Leveling the SSA whiffletrees. ....	54
Figure 32 – The calculated diaphragm shim-stack placement. ....	55
Figure 33 – The installation of the MRF with a drill bit and the lower and middle nut-washer-washer sets in place. ....	58

---

Figure 34 – The three MRFs highlighted are located closest to the central diaphragm. ....	59
Figure 35 – The O-rings in place for the three inner MRFs. ....	60
Figure 36 – The straws added to the moving arm hub. ....	60
Figure 37 – An integration table vertical slide ‘in the B position’.....	61
Figure 38 – An integration table vertical slide prior to lowering the SSA to within 7” of the working position. ....	62
Figure 39 – Level the integration table using lifting jacks under the legs as necessary. ....	63
Figure 40 – Adjust the level of the integration table using the floor jacks.....	63
Figure 41 – Check the level of the table with a circular bubble level. ....	64
Figure 42 – There is approx. 7” between the hardened flat and the chrome ball. ....	65
Figure 43 – The alignment posts are not in place yet. ....	66
Figure 44 – Lowering the SSA for integration. ....	67
Figure 45 – The guide rods in place. ....	68
Figure 46 – Feed the green straws through the small triangles and down onto the threaded ends of the mirror rod flexures. ....	69
Figure 47 – The green straws fitted to all the mirror rod flexures.....	70
Figure 48 – Using guide straws for central diaphragm stud alignment.....	71
Figure 49 – Lowering the SSA towards the segment for final integration.....	72
Figure 50 – The measurement spots to confirm the distance between the S2 glass surface and the datum surface on the backside of the moving frame arms.....	73
Figure 51 – The SSA resting on the segment. ....	74
Figure 52 – All the MRF hardware is tightened.....	75
Figure 53 – Tightening the central diaphragm studs. ....	76
Figure 54 – Tangential restraint with nuts fitted at each end. ....	77
Figure 54 – Custom 7 mm wrench for use with the tangential restraint fasteners. ....	78
Figure 55 – Torqueing the tangential restraint arm fasteners. ....	79
Figure 56 – The tangential restraint.....	79
Figure 57 – Removing the collar clamp to release the Delrin balls.....	81
Figure 58 – Unbolting the dial indicator brackets. ....	82
Figure 59 – The small lift bracket. ....	83
Figure 60 – The large lift brackets. ....	83

Figure 61 – An alignment pin.....	84
Figure 62 – One of the tower locking levers. ....	85
Figure 63 – Spacer pins. ....	85
Figure 64 – The alignment plate attached to the crane.....	86
Figure 65 – The shaft assembly installed on the alignment plate.....	87
Figure 66 – Lowering the alignment plate into position. ....	87
Figure 67 – Spacer pins rising through the surface of the alignment plate. ....	88
Figure 68 – The alignment plate pushing the spacer pin up. ....	88
Figure 69 – Removing the alignment pins.....	89
Figure 70 – Tower alignment tooling. ....	90



## 1. INTRODUCTION

This document describes the procedure for integrating a Bonded Mirror Assembly (BMA) or a dummy aluminum segment with a Segment Support Assembly (SSA).

### 1.1 PURPOSE

The purpose of this document is to provide guidance for TMT M1 fabrication partners in creating Primary Mirror Assemblies, PMAs. In addition it provides guidance for those integrating dummy aluminum segments into SSAs for installation in TMT's MSIT.

### 1.2 SCOPE

This procedure provides step-by-step detailed instruction for the integration of Primary Mirror Assemblies.

### 1.3 APPLICABLE DOCUMENTS

- AD1 SSA Module Assembly, [M1S-100-01200](#).
- AD2 TMT M1 Intermediate Polished Mirror Assembly, [M1S-001-05000, Rev. C](#).

### 1.4 REFERENCE DOCUMENTS

- RD1 TMT M1 Bonded Mirror Assembly drawing, [M1S-001-04000, Rev. A](#).
- RD2 MSIT Aluminum Hexagonal Segment Simulator, Types 10, 15, 16, 20, 21, 22 and 27, [M1S-920-00901 Rev. A](#).
- RD3 SSA Integration Procedure
- RD4 TMT Handling Procedures for Large Optics, [TMT.OPT.TEC.15.065.CCR04](#)

### 1.5 ABBREVIATIONS

- AD Applicable Document
- BMA Bonded Mirror Assembly
- BMAC Bonded Mirror Assembly Component
- FRR Fabrication Readiness Review
- LVDT Linear Variable Differential Transformer
- M1 Primary Mirror
- MRF Mirror Rod Flexure
- MSIT Multi-Segment Integration & Test facility
- N/A Not applicable
- PMA Polished Mirror Assembly
- PPE Personal Protective Equipment



<b>PSA</b>	Primary-Mirror Segment Assembly
<b>RD</b>	Reference Document
<b>SSA</b>	Segment Support Assembly
<b>TBD</b>	To be determined
<b>TIO</b>	TMT International Observatory
<b>TMT</b>	Thirty Meter Telescope
<b>US</b>	United States

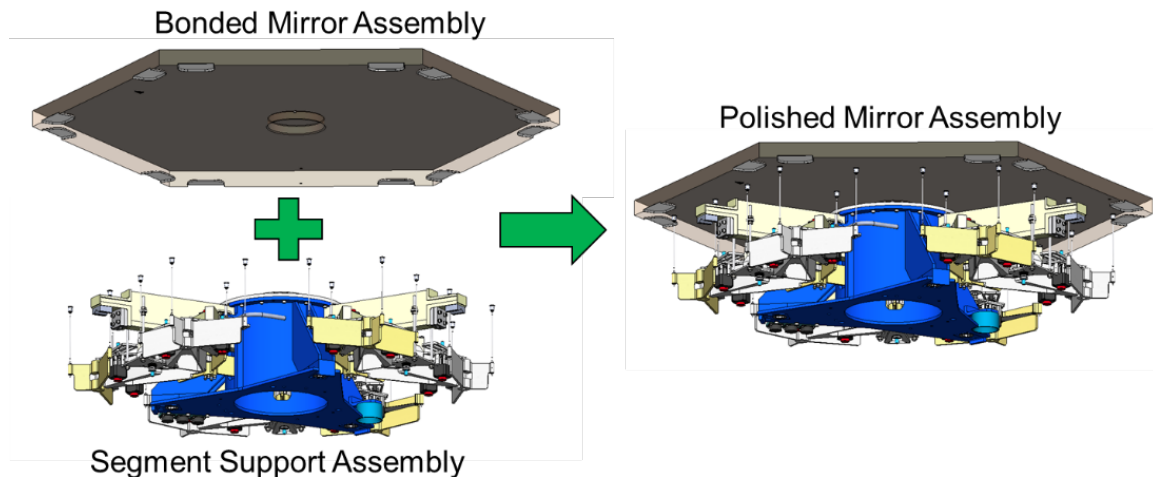
## 2. OVERALL DESCRIPTION

Integrating the Bonded Mirror Assembly (BMA) with the Segment Support Assembly (SSA) is the final fabrication step needed to create a Primary Mirror Assembly (PMA). This document describes the necessary process steps and tooling required to accomplish this.

### 2.1 INTEGRATION

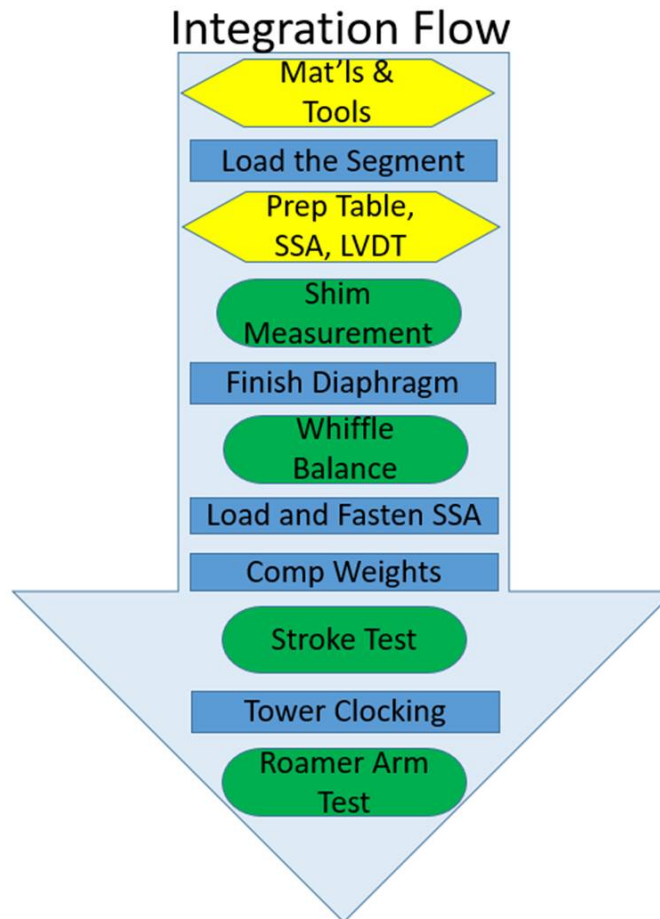
A Bonded Mirror Assembly is comprised of a Polished Mirror Segment with a total of 64 Invar components bonded to it. The Invar components include 27 axial pucks, 24 boot pucks, 12 sensor pucks and a single central diaphragm with twenty bond pads.

This BMA integrates with an SSA to become a PMA. Figure 1 shows the general integration of the two assemblies with each other.



*Figure 1 – PMA integration.*

The flow of integration operations is shown below. Together, these steps encompass the complete integration activity from start to finish.



*Figure 2 – Integration operations.*

## 2.2 INTEGRATION PERSONNEL

Three international partners and one US contractor will be integrating PMAs. Each institute or entity will need guidance in the procedure and tooling to create the assemblies.

### 3. INTEGRATION PROCEDURE

This section provides the details for the TIO-approved integration procedure. Refinements or changes must be approved in advance by TIO and presented in the Integration Fabrication Readiness Review. We expect that this procedure will be the guiding document, even if the partner produces their own document that contains all TIO-approved variations.

#### 3.1 IMPORTANT – SEGMENT TYPES

The following integration procedure relies on tooling and metrology that was originally developed for use with a Type 0 mirror segment. Type 0 segments are not used in the telescope. All segments used in the telescope will be of Types 1 through 82.

The depth of the three registration cones – a critical feature of the segment that is relied upon in the segment integration activity – was changed between the Type 0 segment and subsequent types. Integration tooling (including the integration table) that is configured for use with a Type 0 segment **MUST NOT** be used to integrate segments of types 1 through 82 (i.e. production segments or dummy aluminum segments). To do so will result in errors that can easily result in damage to the segment and associated components.

- ALWAYS confirm the type of segment being integrated before commencing this procedure,
- ALWAYS confirm that the integration tooling is correct and is correctly set up.

The integration tooling can be correctly and safely used for integrating any segment, of Type 0 or Types 1 through 82, but it must be properly configured first. **DO NOT PROCEED** with the integration if there is any uncertainty about which segment type is being used, or which tooling configuration is appropriate.

#### 3.2 MIRROR ASSEMBLIES

##### 3.2.1 Bonded Mirror Assemblies

We expect that each integration partner has previously created a Bonded Mirror Assembly (TMT M1 Bonded Mirror Assembly, M1S-001-04000, Rev. A). The Mirror Assembly consists of a Polished Segment with the following Invar parts bonded to it:

- mirror rod flexure pucks, 27 pieces
- central diaphragm, 1 piece
- edge sensor pucks, 12 pieces
- boot pucks, 24 pieces

The BMA is fully described in RD1.

The following elements of the Bonded Mirror Assembly have unique serial numbers which must be recorded in the in-process data package.

- the mirror segment (all mirror blanks, and each dummy aluminum segment are assigned unique serial numbers),

- the axial pucks (screw-in parts in the case of the dummy segment; bonded parts in the case of the glass segment),
- the central diaphragm,
- the edge sensor and edge sensor boot pucks.

### 3.2.2 Dummy Aluminum Segments

Seven dummy aluminum segments exist for use with SSAs installed into the MSIT. These segments mimic the glass segments in all respects, with the following exceptions.

- the dummy segments are made of aluminum 6061, rather than ClearCeram,
- the mirror rod flexures are attached to the dummy segments through screw-in rather than bonded pucks,
- the central diaphragm is screwed into the dummy segment rather than being bonded in place,
- the S1 ('optical') surface of the segment is flat.

The dummy aluminum segment is fully described in RD1.

## 3.3 SAFETY

This procedure involves working with heavy, fragile components, delicate optics and suspended loads. Working safely is paramount to ensure no personnel are injured or placed in harms way, and no equipment or components are damaged.

TMT has established safe working procedures that must be followed at all times. Safety is the responsibility of everyone on the team.

Note that any employee has the right to call for work to stop immediately if safe working conditions are compromised. Work shall immediately cease until the reason for the unsafe condition(s) are rectified.

### 3.3.1 General safety measures

The following general safety measures shall be taken:

- the activity area, i.e. the area within which the majority of the integration work will take place, shall be kept clean, tidy and well-organized at all times,
- the activity area shall be marked by temporary barriers and appropriate signage,
- no food or drink of any description shall be allowed in the activity area. Use the break room area.
- Personal Protective Equipment, appropriate to the task at hand, shall be used by all personnel at all times,
- do not cause distraction of those working in the activity area. If cell-phone calls and discussions are necessary, take them outside of the activity area where you will not disturb others. Maintain quiet focus within the activity area at all times.

### 3.3.2 Work Permits

Obtain the necessary work permits as part of the activity planning phase. Work permit requirements will vary by site (TMT lab, offsite location or partner location).

DO NOT proceed with the integration activities unless the correct, authorized work permits are in place.



### 3.3.3 Personal Protective Equipment (PPE)

Personal Protective Equipment is provided for your safety and that of others. This procedure will call out PPE requirements throughout. The following general PPE shall be available.

- eye protection (non-prescription safety glasses)
- hard hats and/or bump caps (with chin straps)
- safety shoes (with crush-resistant toe guards and non-slip soles)
- gloves (leather work gloves; ‘surgical’ gloves)

### 3.4 REQUIRED HARDWARE

The hardware listed in Table 1 below is required.

*Table 1 - Required hardware*

<b>Item</b>	<b>Description</b>	<b>Quantity</b>	<b>Note</b>
H1	Mirror Assembly	1	For production, this means a 'Bonded Mirror Assembly'. For use in the MSIT, this means a 'dummy aluminum segment'.
H2	Segment Support Assembly (SSA)	1	M1S-100-01200
H3	Mirror Rod Flexures	27	M1S-100-01111. Each mirror rod flexure has a unique serial number.
H4	Diaphragm studs	6	M1S-100-01122
H5	Centering boss	1	M1S-100-01247
H6	Tangential restraint kit	1	M1S-100-00002
H7	Diaphragm shim pack	1	M1S-100-00001. Kit contains shims with thicknesses ranging from 0.025 to 0.500 mm.
H8	PMA fastener kit	1	P/N TBD
H9	Compensation weight kit	1	M1S-100-01115





When integrating a dummy aluminum segment, the following additional hardware is required.

*Table 2 - Additional hardware required for integrating dummy aluminum segments*

<b>Item</b>	<b>Description</b>	<b>Quantity</b>	<b>Supplier</b>	<b>Note</b>
HA1	Dummy segment Mirror Rod Flexure pucks	27		These pucks screw into the non-optical (S2) side of the aluminum segment and form the segment attachment points for the Mirror Rod Flexures.

### **3.5 PERSONNEL**

For the integration procedure, one Leader and three Assistants are required.

### **3.6 REQUIRED TOOLING**

The following tooling is required to perform the integration activity.



*Table 3 – Required tooling*

Item	Description	Quantity	Supplier	Note
T1	Integration table	1		
T2	Three-leg spanner	1		Excelis/Harris part number 944-634
T3	Three-leg spreader bar	1		
T4	Nylon lifting straps	3		
T5	Clevises	3		
T6	Lifting bars	3		
T7	Precision level	1	McMaster <a href="#">21515A211</a>	Starrett No. 98 Machinist level
T8	Bubble level, circular	1	McMaster <a href="#">2198A87</a>	
T9	Hydraulic scissor jack	2	McMaster <a href="#">28985T15</a>	
T10	Long green straws	30		OD: 4.0 mm; ID: 3.0 mm; L: 304.8 mm; Color: green.
T11	Short straws	2		
T12	LVDT position measuring gauge, and display unit	1		<a href="#">Heidenhain ND 287</a> Display Unit
T13	LVDT holder	1		Used to hold the LVDT probe.
T14	Parallels with 4 Precision-Ground Sides, 6" Long x 3/8" Thick x 3/4" High	1	McMaster <a href="#">2259A17</a>	
T15	Depth gauge	1		Mitutoyo TBD
T16	Delrin ball, 1.5 in. dia.	3		

T17	Special tangent restraint tools	1		
T18	Magnetic socket, 8 mm, 3/8" square drive	1	McMaster <a href="#">7193A2</a>	Used for diaphragm stud nuts
T19	8mm deep socket			Used for the diaphragm stud nuts
T20	O-rings, Viton, 1.42 mm ID x 1.52 mm W.	3	Parker 2-003 or equivalent	Used to retain nuts and washers on inner three MRFs
T21	Steel rod, 2 mm dia. × 25 mm lg.	1		Used to set MRF thread engagement
T22	Loctite 243 thread locker compound	1	McMaster <a href="#">91458A115</a>	
T23	Epoxy adhesive, 3M, 2216	1	McMaster <a href="#">75045A65</a>	Final staking
T24	Vinyl tape	As required		Not used with the dummy aluminum segment
T25	1/4" square drive socket extension, chrome, 14" lg.	1	McMaster <a href="#">5521A19</a>	Used for Diaphragm studs
T26	Electronic torque wrench, set for 20 Nm torque	1		Used to measure torque required to install center boss
T27	Torque wrench, set for 0.75 Nm torque	1	Mountz	
T28	Custom, slotted 7 mm wrench for use with the tangential restraint fasteners	1	N/A	See Figure 55. This is a modified 7 mm wrench.
T29	Allen wrench, T-handle, 5 mm hex x 14 in. lg.	1	Bondhus <a href="#">16464</a>	



When integrating a dummy aluminum segment, the following additional tools are required in order to be able to lift the segment using the crane.

*Table 4 - Additional tooling required for integrating dummy aluminum segments*

Item	Description	Quantity	Supplier	Note
TA1	Forged steel hoist ring for lifting, M14 x 2 thread size, 168 mm overall height	3	McMaster <a href="#">3005T155</a>	These attach to lifting points on the edge of the dummy aluminum segment
TA2	Nylon lifting straps	3	TBD	
TA3	Lifting shackles	3	TBD	

### 3.7 LOADING THE SEGMENT

The first operation is to load the segment to be integrated onto the integration table (T1). Before the segment is lifted in, the integration table is set in its working location and leveled. It is not moved thereafter. Also, make sure that the SSA, the segment, the integration plate and the integration table are within the crane working zone.



Figure 3 – The integration table prior to being finally positioned.

### 3.7.1 Lift the mirror segment

Note that different equipment and methods are used depending upon whether a glass or aluminum segment is being lifted. Refer to the appropriate sections below.

#### 3.7.1.1 Lifting a glass segment

(Initial)	<p>Use the three-leg spanner (T2) to lift the segment with S1, the optical surface, down.</p> <ul style="list-style-type: none"> <li>• Make sure that the optical surface is protected with vinyl tape or equivalent.</li> <li>• Hard hats should be worn during lifting procedures, and must have a strap to retain them (to protect the optic). Steel toe shoes are needed.</li> <li>• Prior to lifting the segment, the leader shall ensure the area is clear, the path to the segment is clear, and that everyone involved knows what their role is.</li> </ul> <p>The aim is to minimize the segment time in the air. Crane operator to ensure proper rigging and load requirements of all lifting gear.</p>
-----------	---

#### 3.7.1.2 Lifting a dummy aluminum segment

(Initial)	Use the three-leg spreader bar (T3) to lift the segment with S1, the ‘optical’ surface, down.
-----------	---



*Figure 4 – Craning an aluminum dummy segment. The S2 surface is uppermost.*

### 3.7.2 Load the segment on the integration table

(Initial)	Position the segment such that the index mark on the S2 (non-optical) surface is pointing in the Negative Y (-Y) direction as shown in Figure 5. Maintain some tension on the nylon straps as the segment rests on the three support pads.
-----------	--

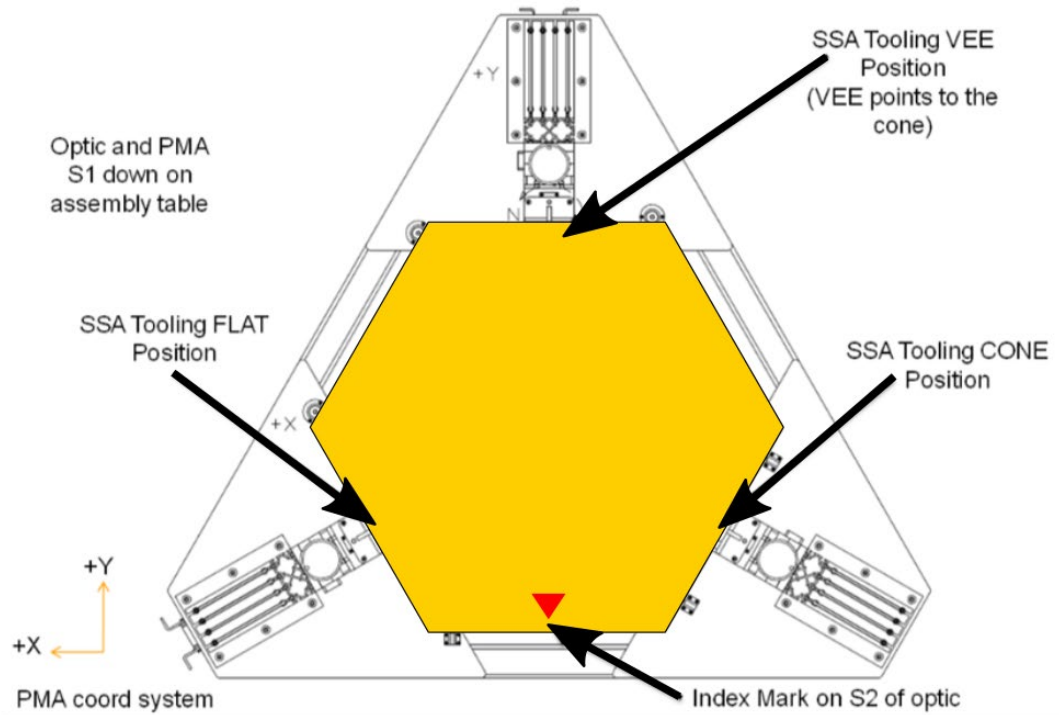


Figure 5 – Correct orientation of the segment on the integration table.

### 3.7.3 Place the segment edges against the fixed pads

Note that setting the segment against the fixed pads will cause the center pocket and cone datum features on the segment to be slightly mis-aligned with respect to the center of the integration table. This misalignment arises because the hexagons of non-Type-0 segments are irregular and vary slightly in size.

(Initial)	Place the segment edges up against the three fixed cylindrical pads as shown in Figure 6. Lower the crane and release the nylon strap tension, such that the segment is now fully supported by the integration table and is touching the fixed circular pads in three locations.
-----------	--





*Figure 6 – Place the segment on the integration table so that it is touching the three fixed circular pads as shown.*



### **3.8 CHECK THE BOSS DEPTH OF THE CENTRAL DIAPHRAGM**

It is now necessary to check the vertical position of the central boss of the central diaphragm within the segment.

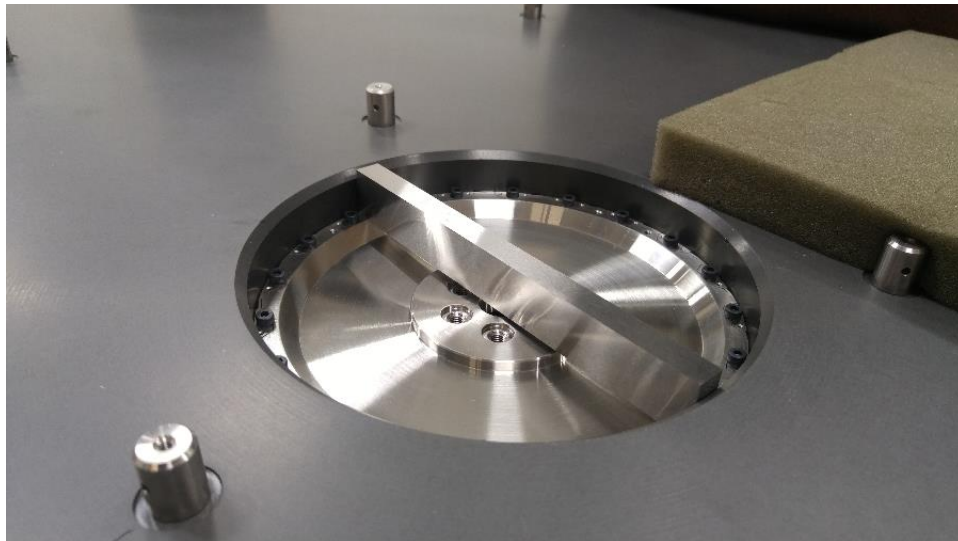
The central diaphragm is a circular flexure that is subject to an effect known as ‘oil-canning’. This effect is sometimes seen in the lids of metal cans when light pressure on the lid can ‘pop’ the position of the lid from one stable orientation to another. It is typically bi-stable, and will remain in one position until sufficient force is applied to move it to the other. It is important to know whether or not the central diaphragm is ‘oil-canned’ and if so, by how much and in which direction.

For a central diaphragm installed in a segment, we define the ‘oil-canning’ state as

- ‘Zero’ – the diaphragm is not ‘oil-canned’ in either direction,
- ‘Negative’ – the diaphragm is ‘oil-canned’ upwards, where ‘upwards’ means in the Z direction away from the S2 surface of the segment,
- ‘Positive’ – the diaphragm is ‘oil-canned’ downwards, where ‘downwards’ means in the Z direction towards the S2 surface of the segment.

### 3.8.1 Measure the central diaphragm boss depth

(Initial)	Place a 6 in. flat parallel bar (T14) across the central diaphragm, rim-to-rim, and use a depth gauge to measure the free-state position of the hub surface. Position the bar carefully to avoid epoxy spots (glass segment, bonded diaphragm) or screw heads (dummy segment, bolted diaphragm). Nominally, the hub is at $1.75 \pm 0.10$ mm below the rim of the diaphragm.
-----------	--



*Figure 7 – Correct placement of the parallel bar across the top of the central diaphragm.*



*Figure 8 – Measure the vertical distance from the top of the parallel bar to the top of the central boss of the central diaphragm.*

(Initial)	<p>Measure and record the height of the parallel bar.</p> <table border="1" style="width: 100%; border-collapse: collapse; margin-bottom: 10px;"> <tr> <td style="width: 40%; padding: 5px;">Height of the parallel bar (D1):</td> <td style="width: 20%;"></td> <td style="width: 10%; text-align: center; padding: 5px;">in.</td> <td style="width: 20%;"></td> <td style="width: 10%; text-align: center; padding: 5px;">mm</td> </tr> </table> <p>Measure the distance from the top surface of the parallel bar to the top surface of the central boss of the central diaphragm, with the diaphragm in its resting position (whether oil-canned or not).</p> <p><i>NOTE: If the diaphragm ‘pops’ or moves when this measurement is made, repeat the measurement in the new stable position.</i></p> <p>Make two measurements at either side of the central diaphragm central boss, and average them. Record this value below.</p> <table border="1" style="width: 100%; border-collapse: collapse; margin-bottom: 10px;"> <tr> <td style="width: 45%; padding: 5px;">Distance from top of parallel bar to top of central diaphragm boss (D2):</td> <td style="width: 35%;"></td> <td style="width: 20%; text-align: center; padding: 5px;">mm</td> </tr> </table> <p>Now calculate Dimension A. It will be exactly zero if the central diaphragm boss is exactly in the design position. It will be positive if the boss is ‘oil-canned’ down (i.e. the boss is less than 1.75 mm from the top edge of the central diaphragm) and negative if the opposite is true (i.e. if it is ‘oil-canned’ up).</p> <p>Dimension A = 1.75 – D2 – D1 (mm)</p> <table border="1" style="width: 100%; border-collapse: collapse; margin-bottom: 10px;"> <tr> <td style="width: 30%; padding: 5px;">Dimension A:</td> <td style="width: 45%;"></td> <td style="width: 25%; text-align: center; padding: 5px;">mm</td> </tr> </table> <p>Dimension A is used later as part of the calculation of the correct shim-stack to be placed between the central diaphragm central boss and the interface with the moving frame.</p>	Height of the parallel bar (D1):		in.		mm	Distance from top of parallel bar to top of central diaphragm boss (D2):		mm	Dimension A:		mm
Height of the parallel bar (D1):		in.		mm								
Distance from top of parallel bar to top of central diaphragm boss (D2):		mm										
Dimension A:		mm										

### 3.9 PREPARE THE INTEGRATION TABLE

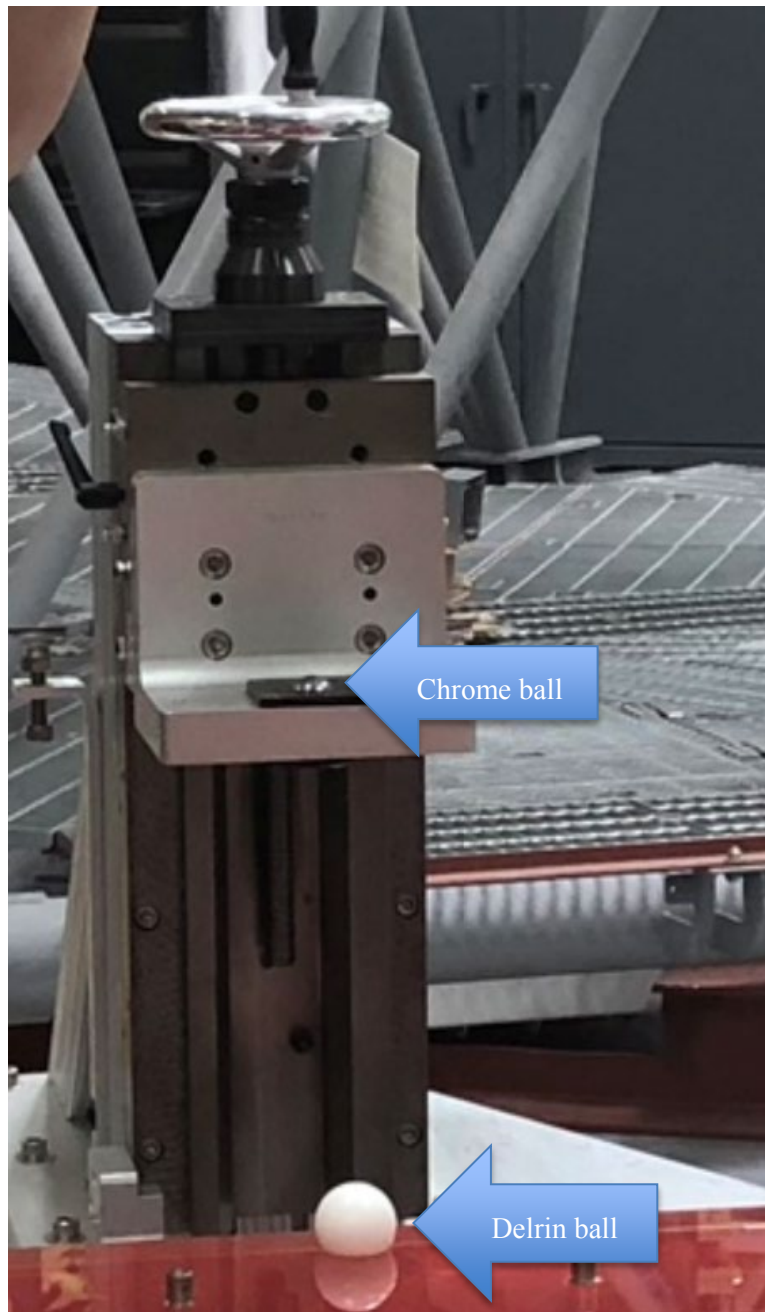
(Initial)	<p>Set all three crank handles on the integration table such that the travel of the sliding stage is nearly all the way vertically upwards, as shown, and lock in place with the black handles on the side of each slide. This is described in notes as being ‘in the B position’.</p>
-----------	--



Figure 9 – Integration table slides ‘in the B position’.

(Initial)	<p>Place the three Delrin balls (T16) in the datum cones on the back of the segment as shown in Figure 10.</p> <p><i>IMPORTANT: Ensure that the Delrin balls are the correct size by measuring and verifying their diameter. Their size is critical and can cause damage if the incorrect ball is used. The correct size is 1.50 in. dia.</i></p>
-----------	---

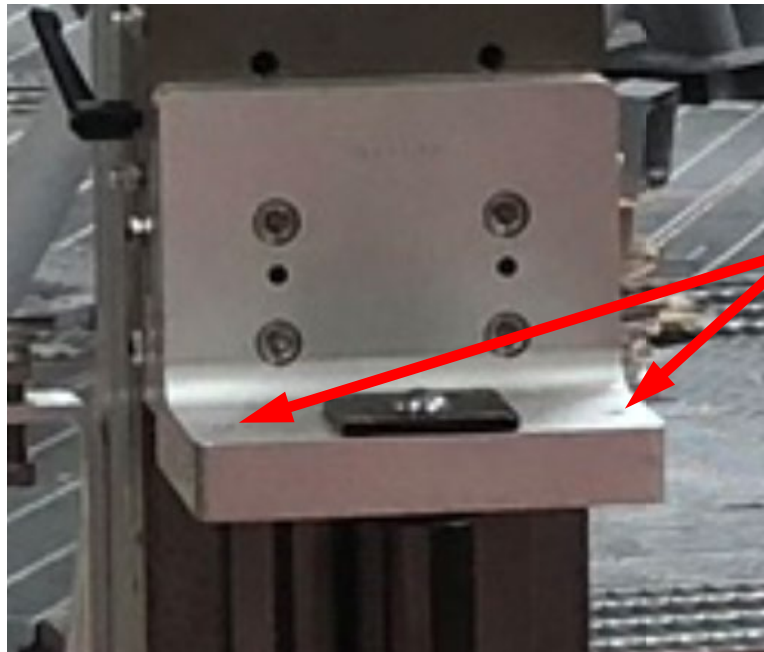
(Initial)	<p>Make sure that the flats that are cut into the Delrin balls are not on the top surface of the ball after they are placed in their cones, and will not interface with the ‘feet’ that they will come into contact with.</p> <p><i>NOTE: The Delrin balls are contacted by the alignment cones on the segment and by ‘feet’ that lower onto them from above. Two of these feet are flat; one has a vee shape.</i></p>
-----------	--



*Figure 10 – A Delrin ball in a segment datum cone.*

(Initial)	Ensure threaded alignment posts are not in place on each of the three slides.
-----------	---





If fitted, alignment posts would be in these holes.

Figure 11 – The alignment posts are not in place yet.

(Initial)	Assign three spotters to guide the SSA during lowering, and to follow it as it is moved down toward the segment. One spotter will take each of the three side flats where the dial indicator brackets are attached. Note that care should be taken when craning SSA close to the crank handles.
-----------	---

### 3.10 PREPARING TO LIFT SSA

Now that the segment is in place on the integration table, it is necessary to lift the SSA onto the integration table also. The following sections assume that a stand is available for the SSA that gives access to the underside of it. If such a stand is not available, some activities in this procedure would require working under a suspended load.

#### 3.10.1 Attach the dial indicator assemblies

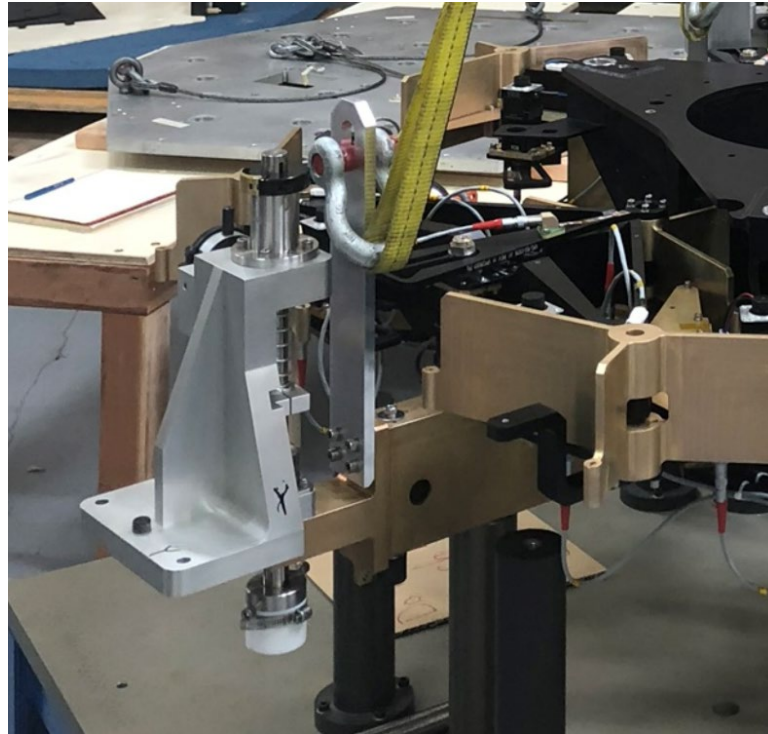
(Initial)	<p>Prior to lifting the SSA onto the integration table, attach the three dial indicator assemblies to the extremities of the moving frame. These assemblies are part of the integration table metrology.</p> <p><i>NOTE: Make sure that the dial indicator assemblies are connected to the specific arm for which they were intended, i.e. the Y, BE or CF arms.</i></p>
-----------	--

(Initial)	<p>Ensure the small button spacer (see Figure TBD) is installed in the bottom of the feet that will be installed onto the actuator ends. One vee foot will be installed onto the Y-arm, and flat feet will be installed on the BE and CF arms.</p> <p><i>CAUTION: If the button spacers are not installed here, the assembly could run out of travel and mistakenly load up the central diaphragm.</i></p>
-----------	--

(Initial)	<p>Install the feet onto the indicator arms. The ‘vee’ foot is on the Y-arm and there are the flat feet on the other arms, i.e. the BE and CF arms.</p>
-----------	---

(Initial)	<p>Install a small shim under each dial indicator, and measure the thickness of each shim so installed.</p> <p><i>NOTE: These shims is needed so that the dial indicators do not run out of range when lowering the SSA onto the segment. The thickness of these shims must match the thickness of the shim that will be placed on central diaphragm in the upcoming step.</i></p> <p>Y arm shim thickness: _____ mm</p> <p>BE arm shim thickness: _____ mm</p> <p>CF arm shim thickness: _____ mm</p> <p>It is expected that the thickness of all the shims should be the same. Record the thickness of the shim as ‘Dimension D’.</p> <p>Dimension D: _____ mm</p> <p>The three dial indicator assemblies are now bolted to the SSA as shown in Figure 12. These are used to align to the integration table with the segment in the Z direction, normal to the segment surface S2.</p>
-----------	--





*Figure 12 – A dial indicator assembly is shown here with one of the three lifting bars.*

### 3.10.2 Attach the three lifting bars

(Initial)	The three lifting bars are each bolted to the end of the moving frame as shown in Figure 12 above. They are not designed to be loaded at an angle, so the load must be applied vertically.
-----------	--

### 3.10.3 Attach the three-arm spreader bar

<p>(Initial)</p>	<p>The three-arm spreader bar is lifted by the crane and connected to the nylon straps with clevises, as shown in Figure 13 below. Note that the protruding portion of each lifting clevis should be oriented towards the center of the SSA. The lifting straps should be attached to the spreader by clevises at the third or fourth holes out from the center. Figure 13 shows them attached at the third hole position.</p> <p><i>CAUTION: Observe the following safety precautions in this and all lifting operations.</i></p> <ul style="list-style-type: none"><li>• <i>Hard hats should be worn during lifting procedures, and must have a strap to retain them (to protect the optic). Steel toe shoes are needed.</i></li><li>• <i>Prior to lifting the SSA, the crew chief to ensure the area is clear, the path to the segment is clear, and that everyone involved knows what their job is.</i></li><li>• <i>The aim is to minimize the SSA time in the air.</i></li><li>• <i>Crane operator to ensure proper rigging and load requirements of all lifting gear.</i></li></ul>
------------------	--





Protruding  
part of Clevis  
Pin should  
face towards  
center of  
SSA

*Figure 13 – Lifting equipment in place, ready to lift the SSA.*

#### **3.10.4 Prepare the LVDT**

An LVDT (T12) is used to make a measurement of the central diaphragm central boss position through the center of the moving frame. This measurement is used later, in the calculation of the shim-stack placed between the central diaphragm central boss and the moving frame.

The LVDT read head is fitted into a holder (T13) before use.



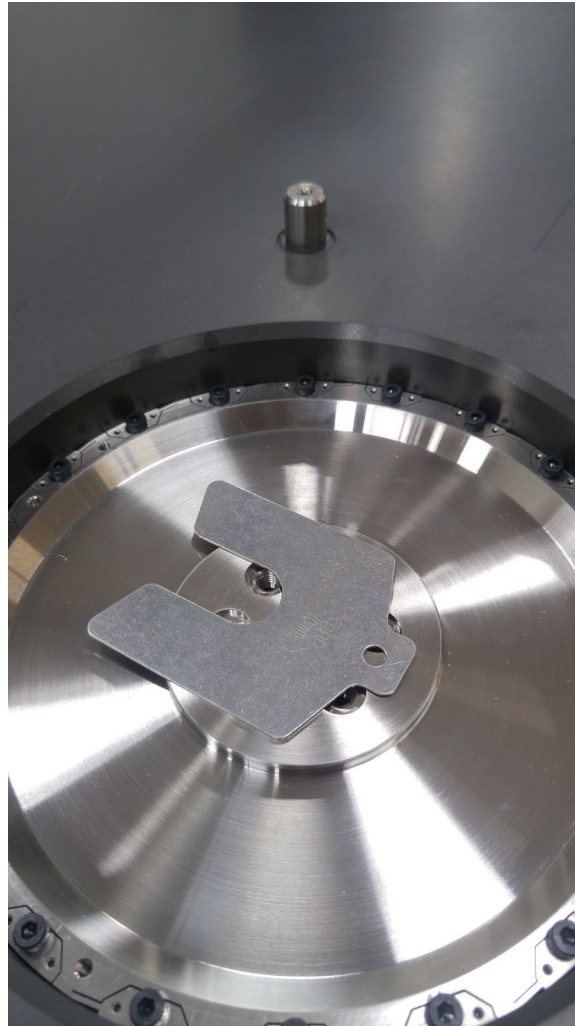
Figure 14 – The LVDT in its holder, with a 75mm green extension straw attached.



Figure 15 – The Heidenhain ND 287 Display Unit used to read the LVDT.

NOTE: The SSA needs to be on a stand that allows for access to the bottom of the moving frame. This will allow for the zeroing of the LVDT.

<p>(Initial)</p>	<p>Place a 0.635 mm shim across the hole in the center of the central diaphragm. This is for the LVDT to touch against during subsequent measurements; see Figure 13.</p> <p>Measure and record the thickness of the placed shim as ‘Dimension C’. It is expected that this shim should be nominally the same thickness as the dial indicator shim thickness recorded earlier, as ‘Dimension D’ in Section 3.10.1.</p> <p>Central diaphragm shim thickness (‘Dimension C’): _____ mm</p>
------------------	--



*Figure 16 – Placing the shim on the central diaphragm.*

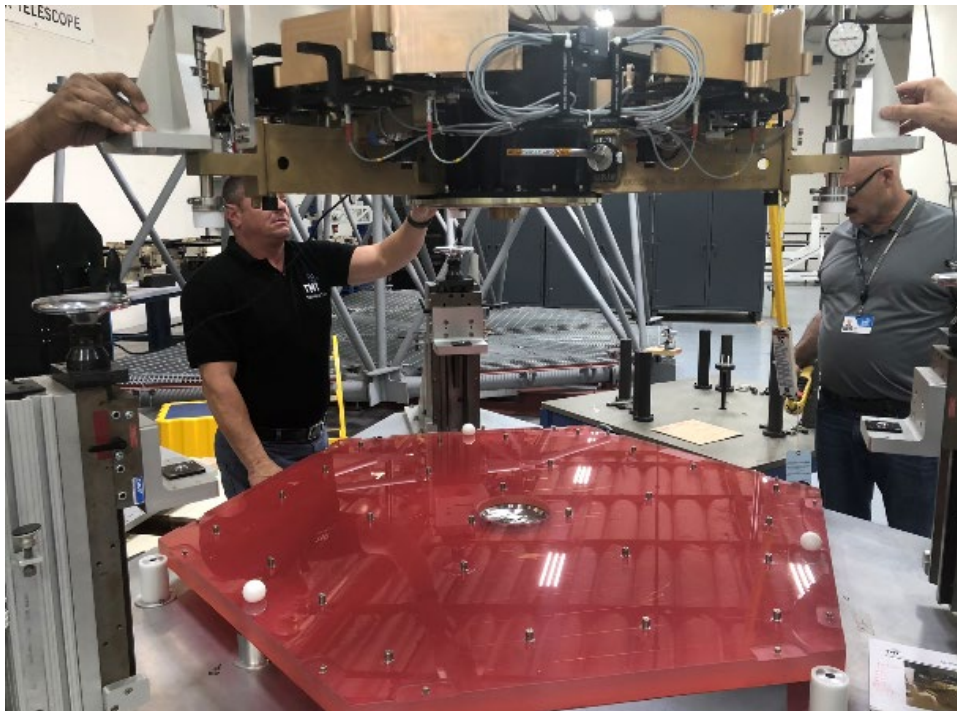
(Initial)	Install the LVDT probe into the gauge holder, as shown in Figure 14 above. Attach a 75 mm long green straw to the end of the LVDT probe to help guide it into place during insertion.
-----------	---

### **3.10.5 Lift the SSA out of the SSA stand**

The following steps describe the process of bringing the SSA to the segment, so that the central diaphragm shim can be measured.



(Initial)	Crane the SSA over the segment in the integration table, with spotters monitoring and reporting position. See Figure 17 below.
-----------	--

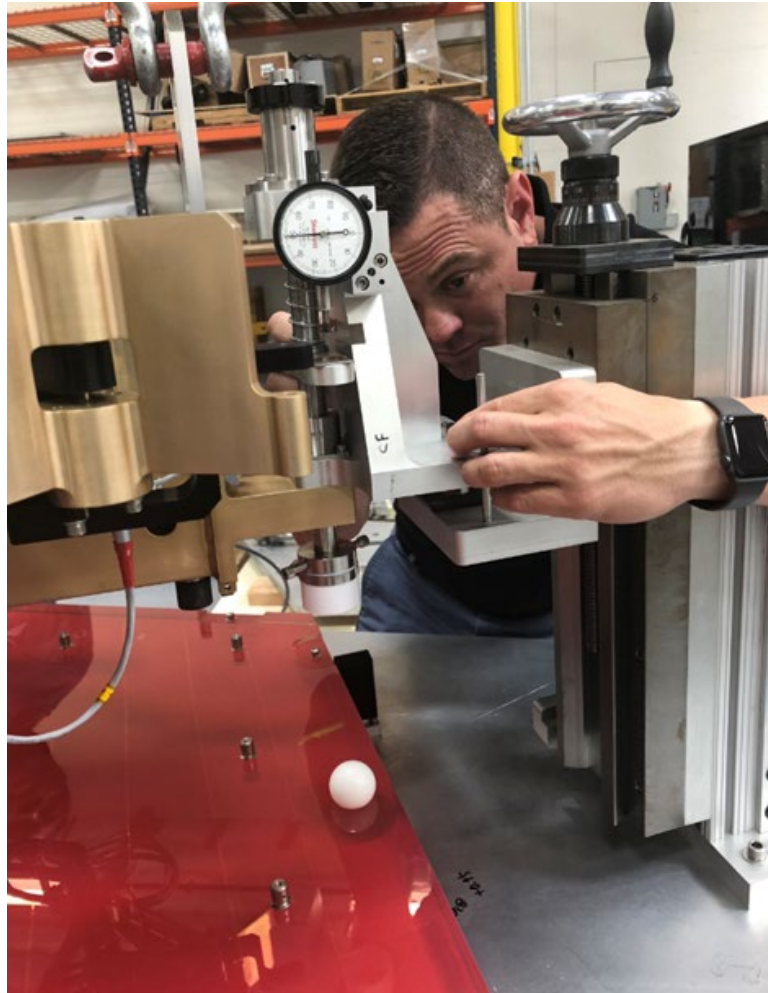


*Figure 17 – Lowering the SSA for shim measurement.*

### 3.10.6 Lower the SSA into the integration table

(Initial)	Lower the SSA using the crane until the recessed hardened pads in the indicator brackets are 1 in. above the chrome balls on the alignment fixture slides.
-----------	--

(Initial)	Install the threaded guide rods on each of the slides, sliding them through the holes in the dial indicator bracket, as shown in Figure 18 below.
-----------	---

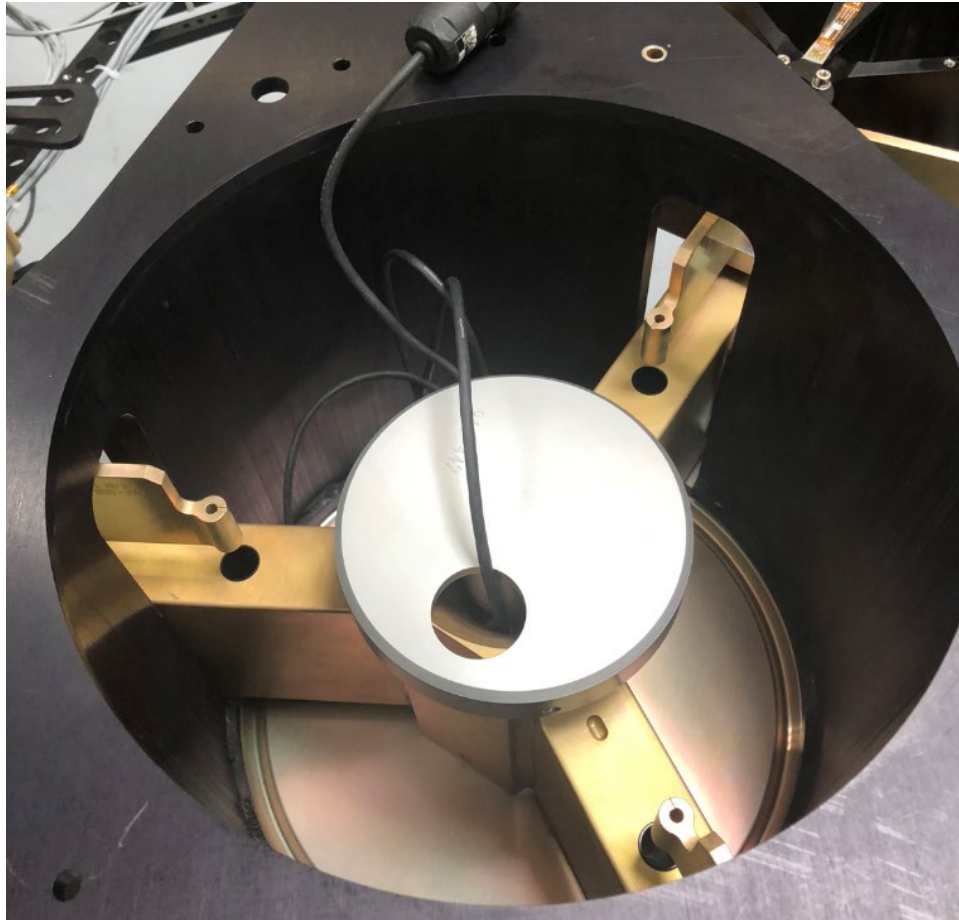


*Figure 18 – Guide rods in place.*

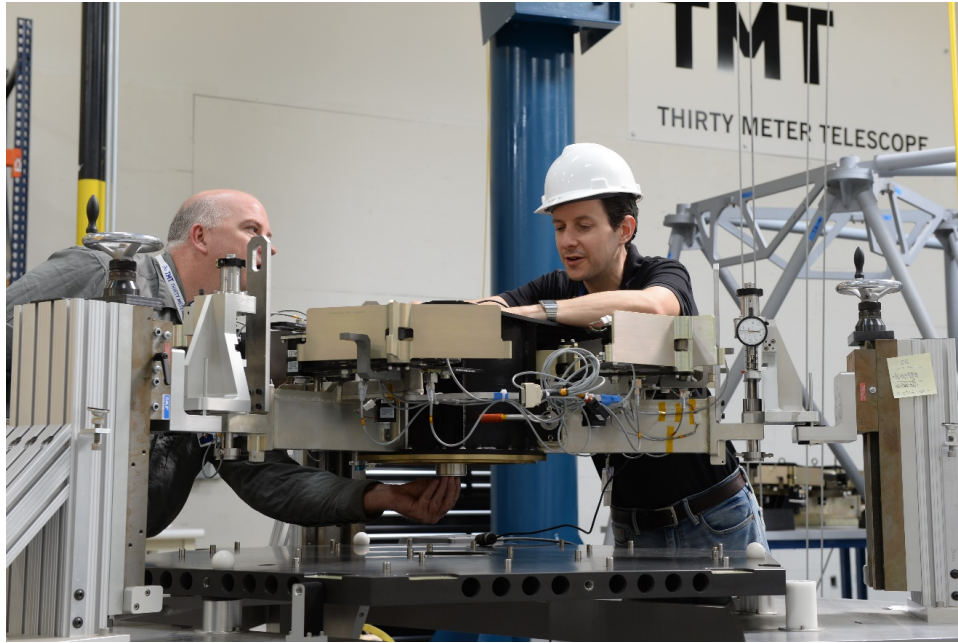
(Initial)	Slowly lower the SSA until the hardened insert is fully seated on the chrome ball on each slide.
-----------	--

(Initial)	Put the LVDT and its holder into place, resting on the center of the moving frame, with the probe tip extending through and beyond the bottom surface of the moving frame hub, as shown in Figure 21 below.
-----------	---





*Figure 19 – The LVDT and its holder resting on moving frame.*



*Figure 20 – Placing the LVDT and its holder in place prior to shim measurement.*





*Figure 21 – The LVDT probe tip extended below the moving frame hub.*

The LVDT needs to stay powered for the next several steps. Use a long mains extension cord and have a spotter monitoring to ensure that it does not become disconnected.

(Initial)	<p>Zero the LVDT by pushing the LVDT probe against the flat plate on the moving frame hub surface. When it is in position, zero the readout by pressing the ‘RESET’ soft-key on the Heidenhain interface.</p> <p><i>NOTE: For the next few steps, the LVDT must remain powered in order to keep this zero reference.</i></p>
-----------	--

(Initial)	<p>Cover the S2 surface of the segment with a slotted foam cover, and remove the shackles from lifting hardware. The foam cover is used to protect against dropping the lifting shackles on the segment.</p>
-----------	--

(Initial)	<p>Remove the slotted foam cover once the lifting shackles have been removed.</p>
-----------	---

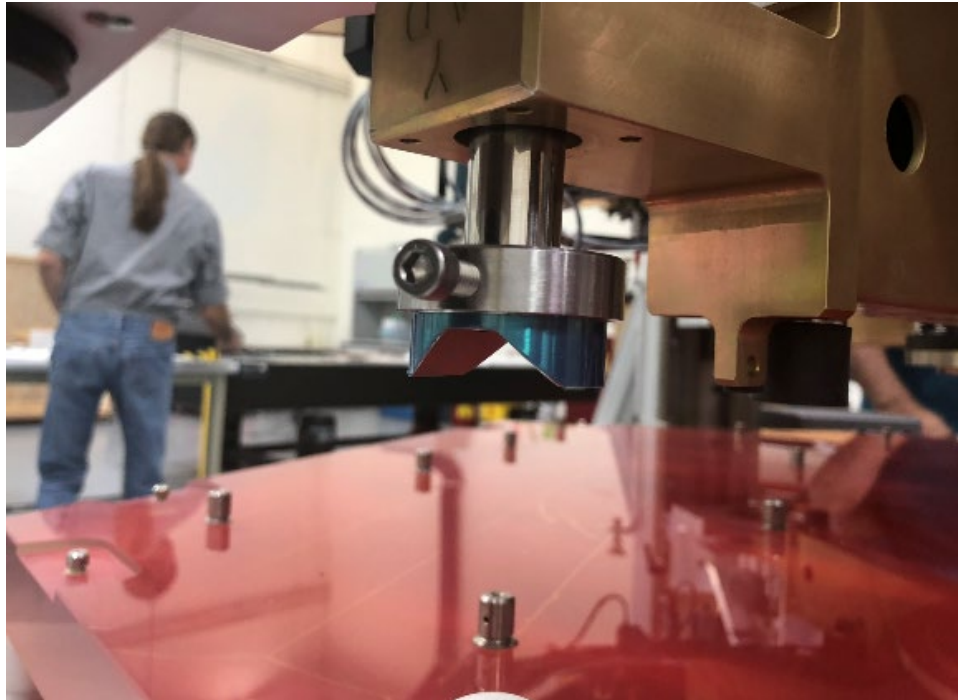
(Initial)	Unlock the slides on the three slide-crank towers by rotating the small black lever on each slide counter-clockwise.
-----------	--

(Initial)	With a person on each slide crank, have the leader call out full turns clockwise to lower the slide and SSA, one turn at a time, until each Delrin ball is $\frac{1}{2}$ in. away from the foot (cone, vee, flat) on the dial indicator brackets.
-----------	---



*Figure 22 – Lowering the SSA towards the segment for shim measurement.*





*Figure 23 – The vee foot with the white ball receiver removed.*

(Initial)	Continue to move the SSA down in half-turn increments until any one of the three dial indicators registers movement.
-----------	--

(Initial)	Read the value from the dial indicator that registered the largest value. Slowly advance the other two crank arms until the dial indicators match the reading on the indicator that moved first (the one indicating the largest value).
-----------	---

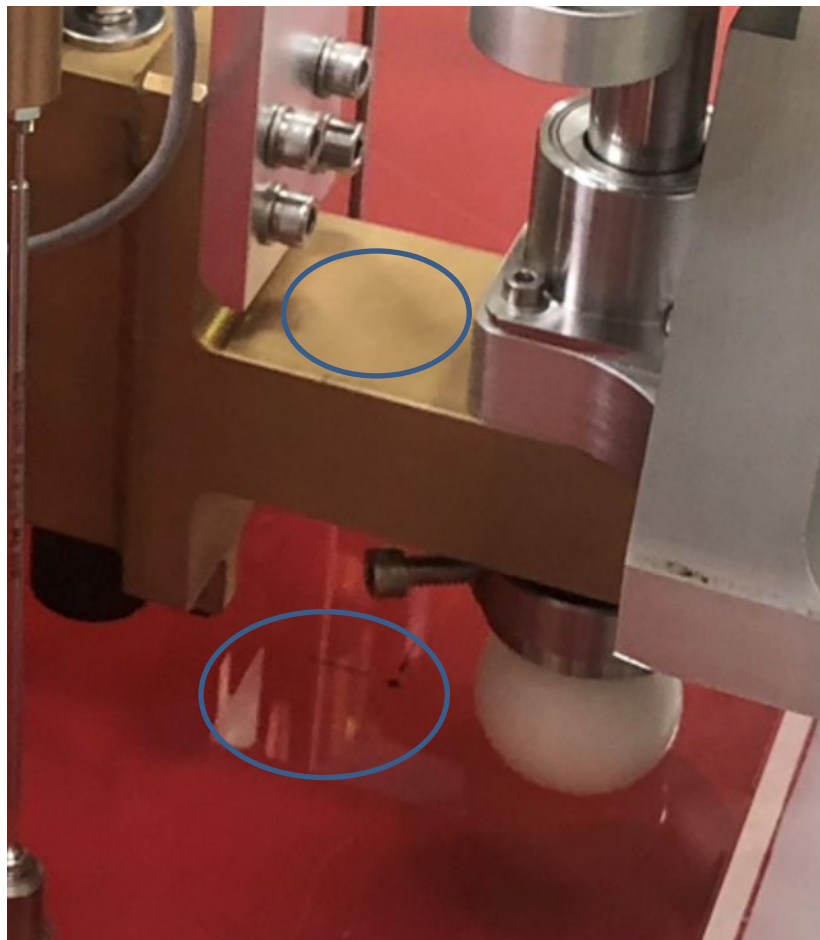
(Initial)	Use a depth gauge to measure between the top surface datum on the moving frame and the S2 surface in three places. <i>NOTE: See Figure 24 below to see where measurement locations are located.</i>
-----------	--

Record the numbers and calculate the travel required to meet the design spacings of **83.932 mm** + shim thickness ('Dimension D'; see Section 3.10.1) under each indicator arm.



(Initial)	Turn the individual hand cranks to achieve the required values above, and confirm that the height of the fixed frame relative to the S2 (non-optical) segment surface is correct (i.e. that it is 83.932 mm + shim thickness under each indicator arm).
-----------	---

(Initial)	Using a depth gauge to measure between the surfaces indicated in Figure 24 below, record the achieved values:		
	<table border="1"><tr><td data-bbox="357 709 609 877">Measured values:</td><td data-bbox="609 709 1266 877">Y arm: _____ BE arm: _____ CF arm: _____</td><td data-bbox="1266 709 1378 877">mm</td></tr></table>	Measured values:	Y arm: _____ BE arm: _____ CF arm: _____
Measured values:	Y arm: _____ BE arm: _____ CF arm: _____	mm	
	<p><i>NOTE: If the measured value does not match the design value, then drive the arms to the nominal. This can be measured using a depth micrometer fitted with an extension, to measure between these two surfaces. All three stations should measure the same value to within 0.050 mm, and should match the design value to within 0.050 mm.</i></p> <p><i>NOTE: The datum dimension is <math>74.254 \pm 0.050</math> mm from the center of the Delrin balls to the moving frame arm flats.</i></p>		



*Figure 24 – The measurement regions (blue circles) to confirm the distance between the S2 surface and the datum surface on the back side of the moving frame arms.*

**3.10.7 Record the dial indicator numbers**

(Initial)	Y arm <u>dial indicator</u> reading: _____ BE arm <u>dial indicator</u> reading: _____ CF Arm <u>dial indicator</u> reading: _____	mm
-----------	--	----

**3.10.8**

**3.10.8 Read the LDVT and record as 'Dimension B'**

(Initial)	LVDT reading ('Dimension B'): _____ mm
-----------	--

**3.10.9 Calculate the central diaphragm shim value**

Below, the value of the shim applied to the top of the central diaphragm is calculated.

(Initial)	<p>Using the values below:</p> <p>Dimension A: _____ (from Section 3.8.1)</p> <p>Dimension B: _____ (from LVDT, Section 3.10.8)</p> <p>Dimension C: _____ (from LVDT shim, Section 3.10.4, nominally 0.635 mm)</p> <p>Dimension D: _____ (from Indicator Shims, section 3.10.1, nominally 0.635 mm)</p> <p>Perform the calculation of the shim thickness:</p> <p>'Dimension B' – 'Dimension A' – 'Dimension C' + 'Dimension D' =          _____ mm</p> <p>Nearest shim combination: _____ (from shim pack)</p> <p><i>NOTE: Before installing the shims at the central diaphragm, measure the total height of the shim stack and record the value below.</i></p> <p>Shim confirmation: measurement _____ mm</p> <p><i>NOTE: The nominal design calls for a 0.5 mm shim.</i></p>
-----------	--

**3.10.10 Raising the SSA off the integration table**

(Initial)	<p>With one person at each slide crank, rotate in the counter-clockwise direction to raise the SSA, 0.005 in. at a time, as shown on the dial indicators.</p>
-----------	---





(Initial)	Once all dial indicators stop registering motion, move one full counter-clockwise turn of the crank at a time, with all three cranks synchronized by the leaders' call-out. Continue until all slides are 'at the B position'.
-----------	--

(Initial)	Lock the three slides using the black levers.
-----------	---

(Initial)	Remove the LVDT and its holder from the SSA.
-----------	--

(Initial)	Re-attach the shackles and the lifting hardware.
-----------	--

(Initial)	With spotters at each of the three lifting positions, slowly crane up the SSA until clear of the crank handle(s) by 6 inches.
-----------	---

(Initial)	Crane the SSA back to the SSA assembly table (see Figure 25) and set it down.
-----------	---





*Figure 25 – The SSA assembly table*

(Initial)	Remove the shims from the three dial indicators.
-----------	--

**3.10.11 Pressing the center boss into the moving frame hub**

(Initial)	MSIT Only: Ensure that the spacer needed to interface a version 3 prototype to the new central diaphragm is installed on moving frame.
-----------	--

(Initial)	The center boss should be cooled to $-15\text{C}$ or below for a minimum of 10 hours prior to installation. This reduces the boss diameter by $\sim 7$ microns, making the press fit easier to achieve. This can be accomplished by placing the boss in the freezer compartment of a conventional refrigerator.
-----------	---

(Initial)	Use an electronic torque wrench (T26) during the next step to measure the torque applied. The expected torque is between 4 and 12 Nm.
-----------	---

(Initial)	Press-fit the center boss into the moving frame hub using a M6 x 50 mm, 15.9 Class bolt (i.e. Bumax Ultra or similar) high-strength bolt and the wrenches on both the head and the nut side of the pressing hardware. See Figure 26 and Figure 27.
-----------	--

(Initial)	<p>A T-handle Allen wrench is used to hold the socket head cap screw through the moving frame from above, while a wrench is used from the bottom to tighten the fastener and drive home the boss, until fully seated.</p> <p>Once fully seated, remove the drive fasteners.</p>
-----------	---

(Initial)	Record maximum torque applied: _____ Nm
-----------	---



*Figure 26 – The center boss as it is pressed into the moving frame hub.*

(Initial)	MSIT ONLY: After the center boss has been pressed in, remove the three flathead screws that were used to retain the shim on the end of the moving frame hub.
-----------	--



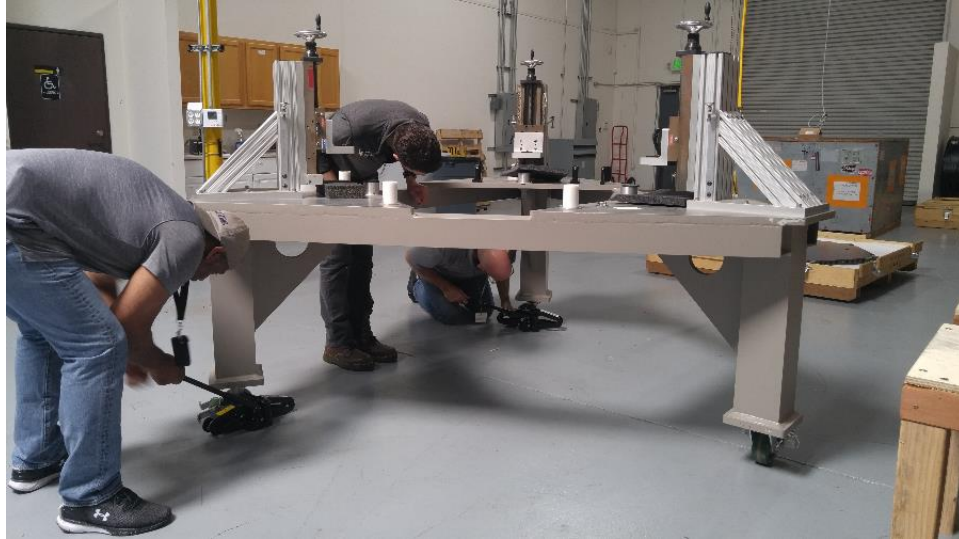
*Figure 27 – The T-handle Allen wrench from the top view, while the center boss is pressed into the hub.*

**3.10.12 Level the SSA assembly table**

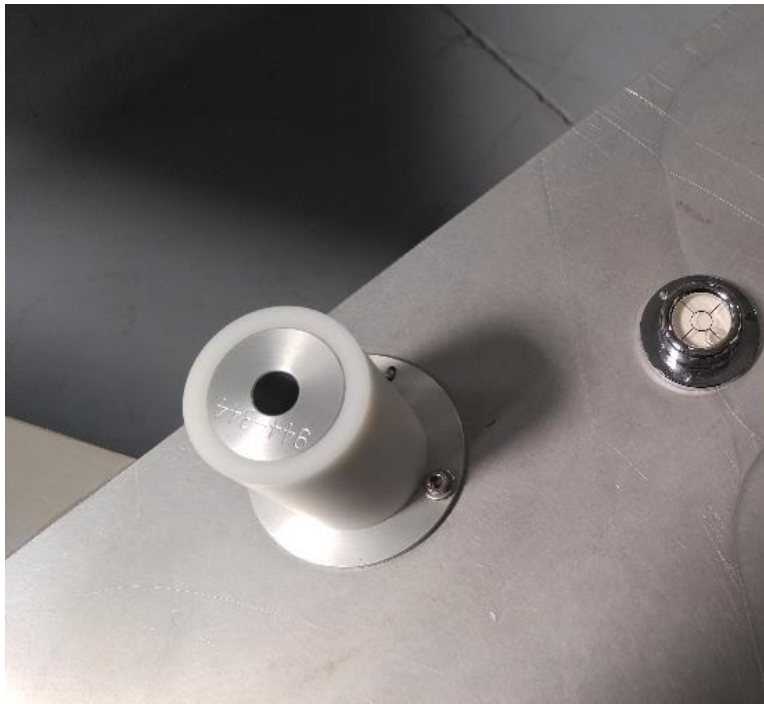
(Initial)	Use a precision bubble level (T8) and floor jacks (T9) to level the integration table. Make sure that the caster wheels are locked and the integration table remains unmoved on the floor for the entire integration procedure. Make sure to place the two jacks under the legs with the pivoting casters.
-----------	--



*Figure 28 – Level the integration table using lifting jacks under the legs as necessary.*



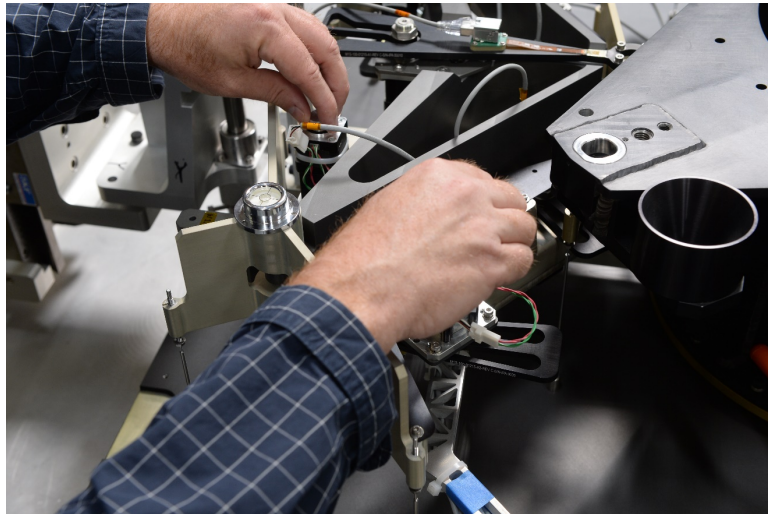
*Figure 29 – Adjust the level of the integration table using the floor jacks.*



*Figure 30 – Check the level of the table with a circular bubble level.*



(Initial)	<p>Balance the whiffletree prior to tightening the mirror rod flexures, starting with the middle triangles. This is done using a bubble level on the triangle and driving it to level using the warping harness motors, as shown in Figure 31. Rather than driving the motors electrically, the stepper motor positions are adjusted ‘by hand’ by turning the knob at the end of each motor’s drive shaft.</p> <p>Perform leveling operation on large middle triangles first then balance each of the small triangles. Each triangle should be level to within ½ bubble.</p>
-----------	--



*Figure 31 – Leveling the SSA whiffletrees.*

**3.10.13 Fitting central diaphragm hardware**

Insert the six studs into the central diaphragm hub, with a small amount of Loctite 243 on the threads.

(Initial)	<p>Apply a drop of Loctite 243 with a wooden toothpick, and then torque each of the six diaphragm studs to <math>0.75 \pm 0.05</math> Nm.</p>
-----------	---

(Initial)	<p>Install the proper shims as calculated in Section 3.10.9 above. See Figure 32 below.</p>
-----------	---



*Figure 32 – The calculated diaphragm shim-stack placement.*

#### **3.10.14 Install the mirror rod flexures**

The mirror rod flexures (MRFs) are now installed. Each MRF has three sets of nuts and associated washers (both flat and lock types).



<p>(Initial)</p>	<p>Record the serial numbers of each of the twenty-seven mirror rod flexures below:</p> <ol style="list-style-type: none"><li>1. S/N: _____</li><li>2. S/N: _____</li><li>3. S/N: _____</li><li>4. S/N: _____</li><li>5. S/N: _____</li><li>6. S/N: _____</li><li>7. S/N: _____</li><li>8. S/N: _____</li><li>9. S/N: _____</li><li>10. S/N: _____</li><li>11. S/N: _____</li><li>12. S/N: _____</li><li>13. S/N: _____</li><li>14. S/N: _____</li><li>15. S/N: _____</li><li>16. S/N: _____</li><li>17. S/N: _____</li><li>18. S/N: _____</li><li>19. S/N: _____</li><li>20. S/N: _____</li><li>21. S/N: _____</li><li>22. S/N: _____</li><li>23. S/N: _____</li><li>24. S/N: _____</li><li>25. S/N: _____</li><li>26. S/N: _____</li><li>27. S/N: _____</li></ol>
------------------	---



(Initial)	Ensure the 'middle thread' of the MRF has flat washer installed first, followed by a lock washer and lastly a nut. Ensure that the nut is on the last or bottom of the middle thread.
-----------	---

(Initial)	Place a 2 mm dia. rod, or drill bit, through the cross-hole in the axial puck.
-----------	--

(Initial)	Make sure the bottom end has a nut, followed by a lock washer and lastly a flat washer
-----------	--

(Initial)	Lightly hand-tighten the MRF clockwise into the puck until slight resistance is felt as the drill bit is contacted. This ensures proper MRF thread engagement.
-----------	--

(Initial)	Tighten the lower nut, finger-tight at first.
-----------	---

(Initial)	A third nut-washer-washer set for the upper MRF thread is set aside for the moment, for the final tightening sequence.
-----------	--



*Figure 33 – The installation of the MRF with a drill bit and the lower and middle nut-washer sets in place.*

(Initial)	Lock the lower nut at a torque of $1.0 \pm 0.1$ Nm, for all 27 MRFs.
-----------	--

(Initial)	The three MRFs closest to the central diaphragm (Figure 34) should also have a small Viton O-ring installed below the nut of the middle thread during installation as a safety measure, so that the nut and washers stay in place. See Figure 35.
-----------	---

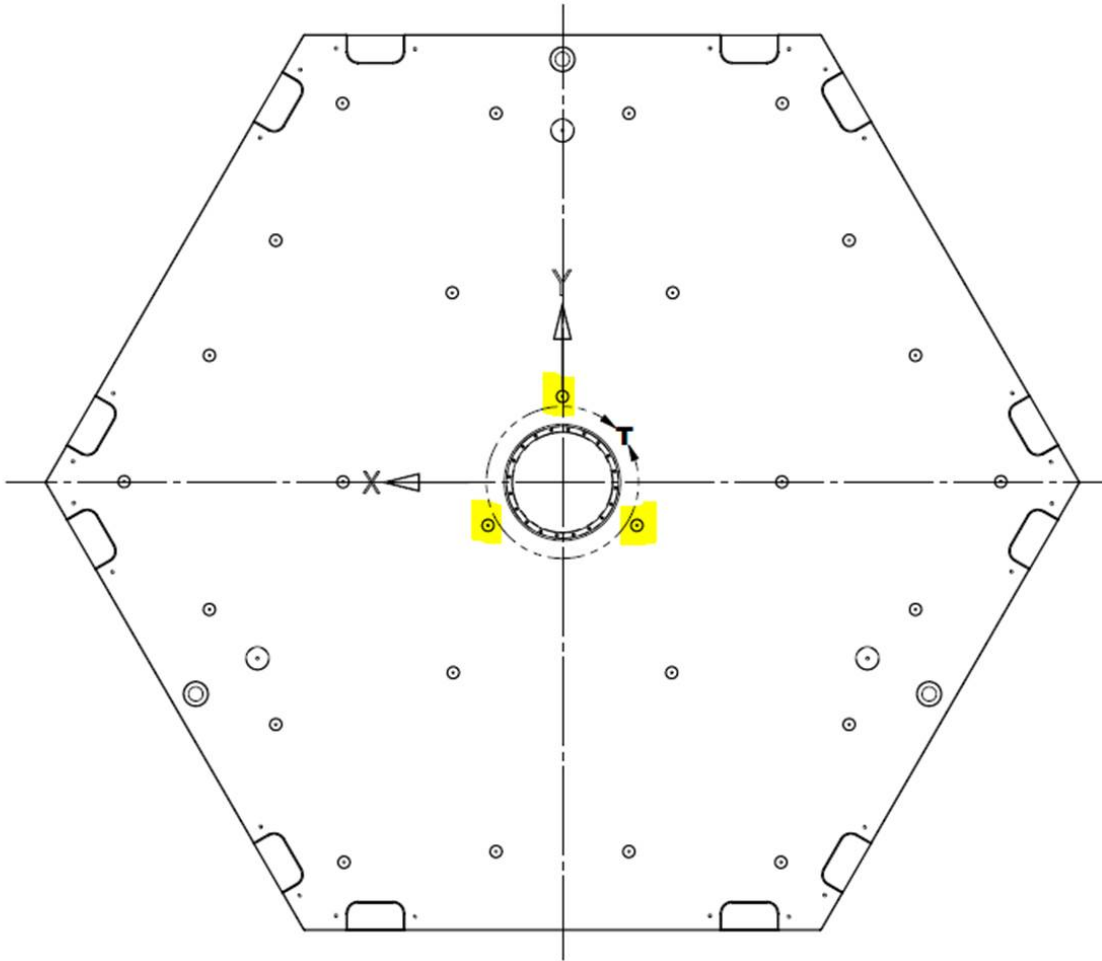


Figure 34 – The three MRFs highlighted are located closest to the central diaphragm.

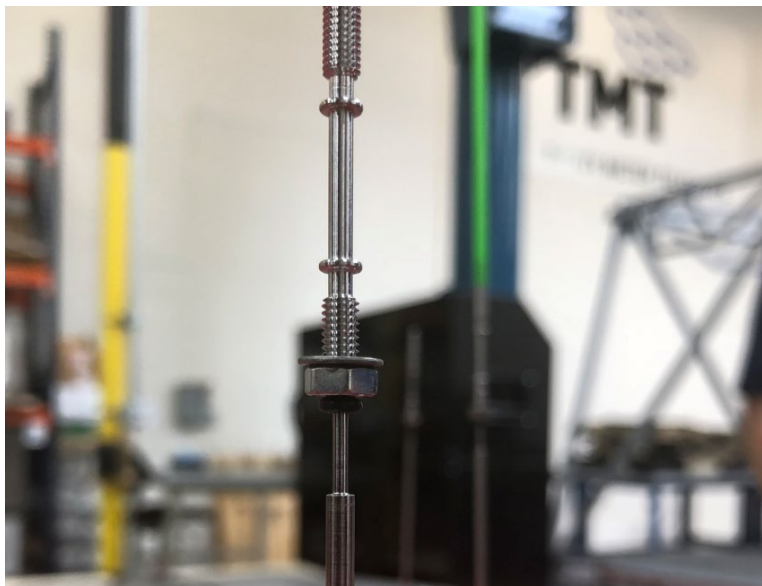


Figure 35 – The O-rings in place for the three inner MRFs.

### 3.10.15 Prepare to load the SSA onto the segment

(Initial)	<p>Add the short straws to the moving frame hub through holes, as shown in Figure 36 below. These will be used to guide the (moving frame?) center boss into the (central?) diaphragm center boss and studs.</p> <p><i>NOTE: Determine the size of the short straws and put them in the SSA kit.</i></p> <p><i>NOTE: It is also acceptable to use two short green straws with the diaphragm studs.</i></p>
-----------	--

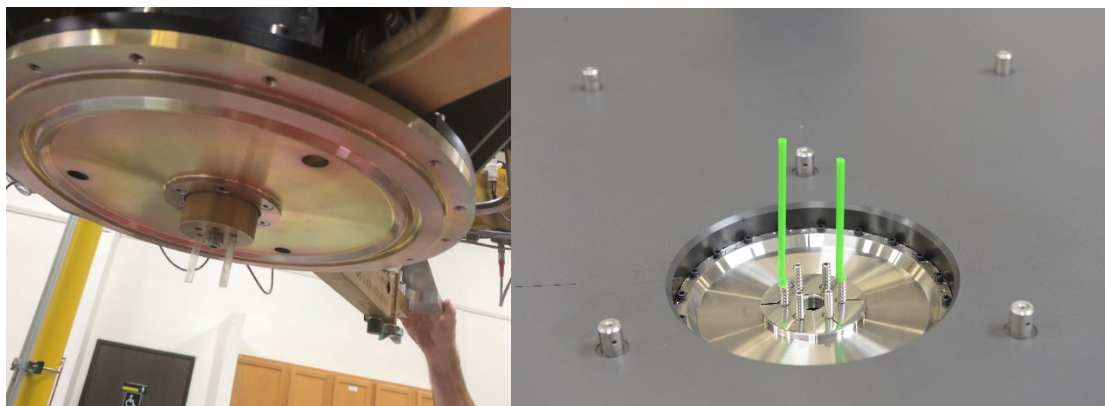


Figure 36 – The straws added to the moving arm hub.

(Initial)	Check all three crank handles on the integration table are such that the travel of the sliding stage is all the way vertically upwards, as shown, and lock in place by turning the black handle on the side of each slide clockwise. This is described as placing them ‘in the B position’ as shown in Figure 37.
-----------	---

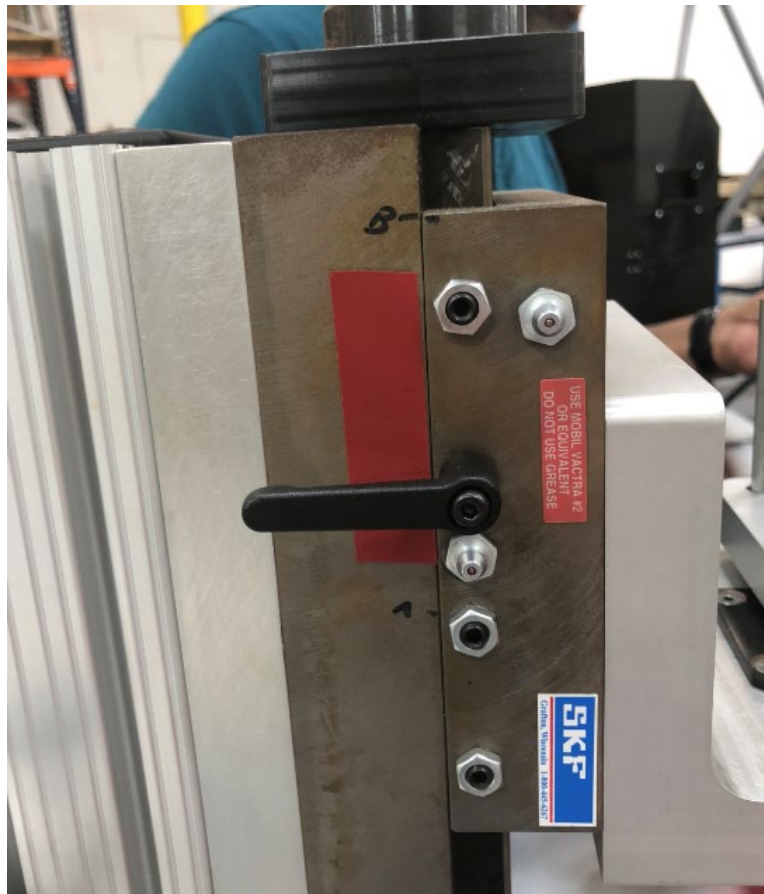
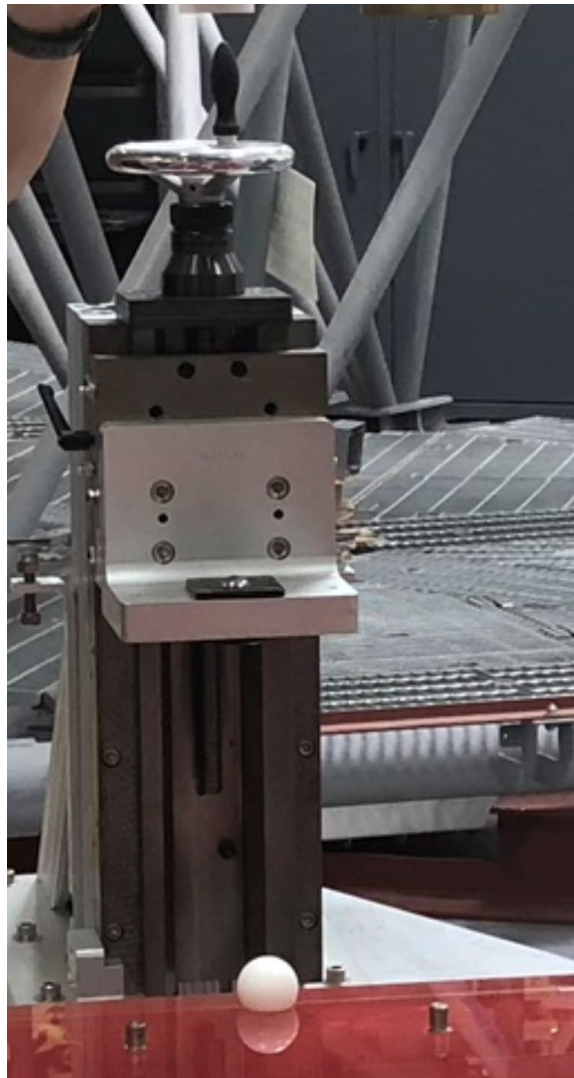


Figure 37 – An integration table vertical slide ‘in the B position’.



*Figure 38 – An integration table vertical slide prior to lowering the SSA to within 7” of the working position.*

**3.10.16 Level the integration table**

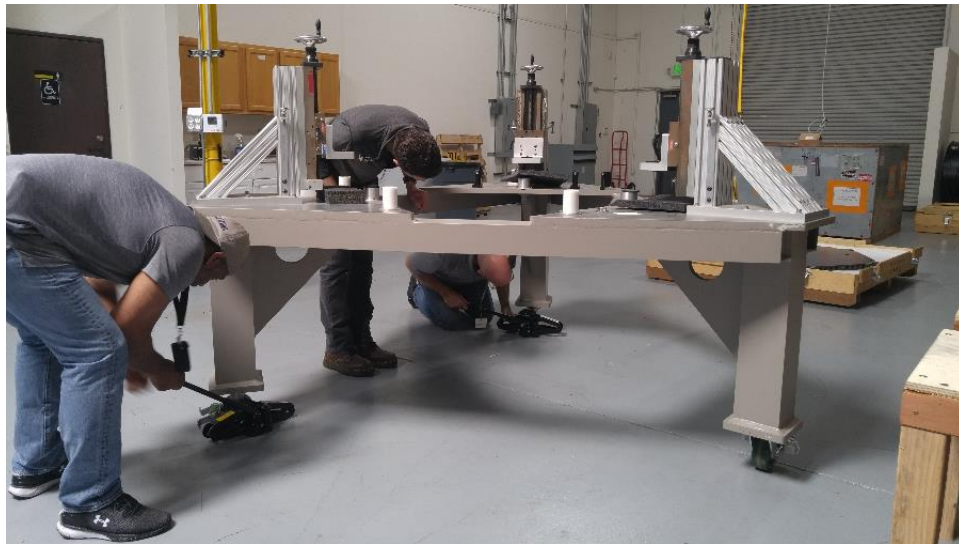
At this point it is necessary to level the integration table.

(Initial)	Use a precision bubble level (T8) and floor jacks (T9) to level the integration table. Make sure that the caster wheels are locked and the integration table remains unmoved on the floor for the entire integration procedure. Make sure to place the two jacks under the legs with the pivoting casters.
-----------	--

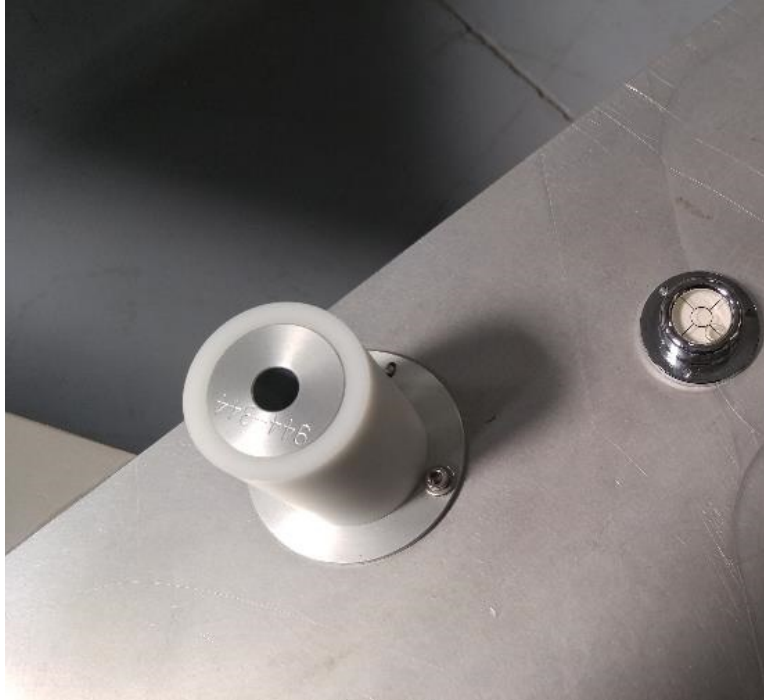




*Figure 39 – Level the integration table using lifting jacks under the legs as necessary.*



*Figure 40 – Adjust the level of the integration table using the floor jacks.*

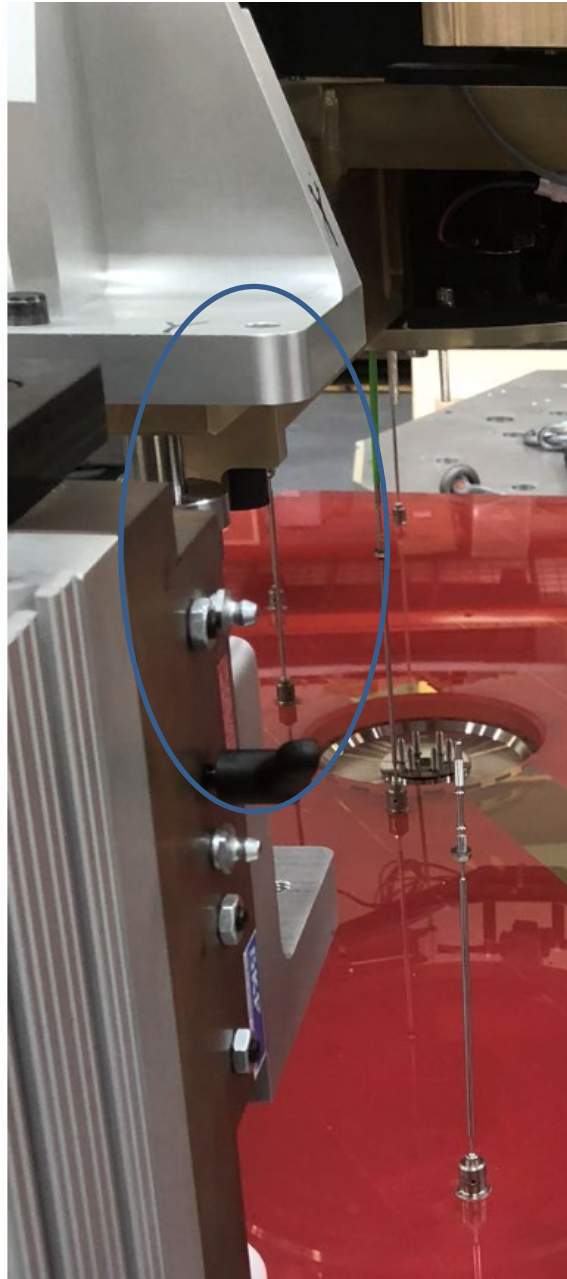


*Figure 41 – Check the level of the table with a circular bubble level.*

### 3.10.17 Lower the SSA onto the segment

(Initial)	Crane the SSA back over the integration stand, and lower the SSA until there is 7” of clearance between the hardened seat of the dial indicator bracket and the chrome balls. See Figure 42 below.
-----------	--





*Figure 42 – There is approx. 7” between the hardened flat and the chrome ball.*

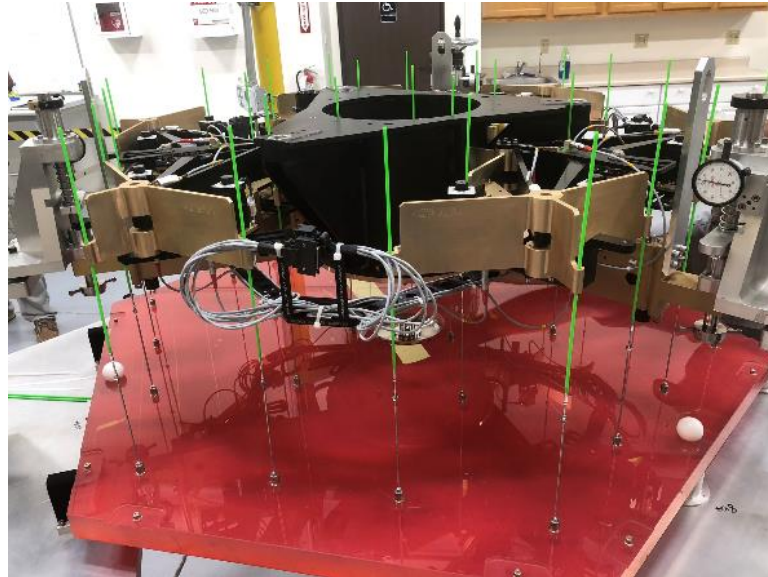
(Initial)	<p>Have a spotter watch the nuts on the three mirror rod flexures closest to the central diaphragm.</p> <p><i>CAUTION: These nuts and washers will need to clear holes in the guide flexure as the SSA is brought down in the next section.</i></p>
-----------	---

(Initial)	<p>Check the Delrin balls are still in place.</p> <p><i>CAUTION: Ensure the Delrin balls are the correct size by measuring their diameter. The correct size of the Delrin balls is 1.500 in. dia. Other sizes do exist, so check. This is critical and can cause damage if incorrect diameter used.</i></p> <p><i>CAUTION: Ensure threaded alignment posts <u>are not</u> in place on the slide, see Figure 43.</i></p>
-----------	---



If fitted,  
alignment posts  
would be in  
these holes.

Figure 43 – The alignment posts are not in place yet.



*Figure 44 – Lowering the SSA for integration.*

Lower the SSA using the crane, until the recessed hardened pads in the indicator brackets are 1 in. above the chrome balls on the integration table slides.

Install the threaded guide rod on the slide, sliding it through the hole in the dial indicator bracket, as shown in Figure 45 below.



*Figure 45 – The guide rods in place.*


Slowly lower the SSA until the hardened insert is fully seated on the chrome ball.

(Initial)	Cover Segment with a slotted foam cover and remove the shackles from lifting hardware. The foam is used to protect against dropping the lifting shackles on the segment.
-----------	--

(Initial)	Remove the slotted foam cover once the lifting shackles have been removed.
-----------	--

(Initial)	Install the green straws through the holes in the small triangles of the whiffletree, and down onto the threaded ends of the mirror rod flexures, as shown in above.
-----------	--



Figure 46  Feed the green straws through the small triangles and down onto the threaded ends of the mirror rod flexures.



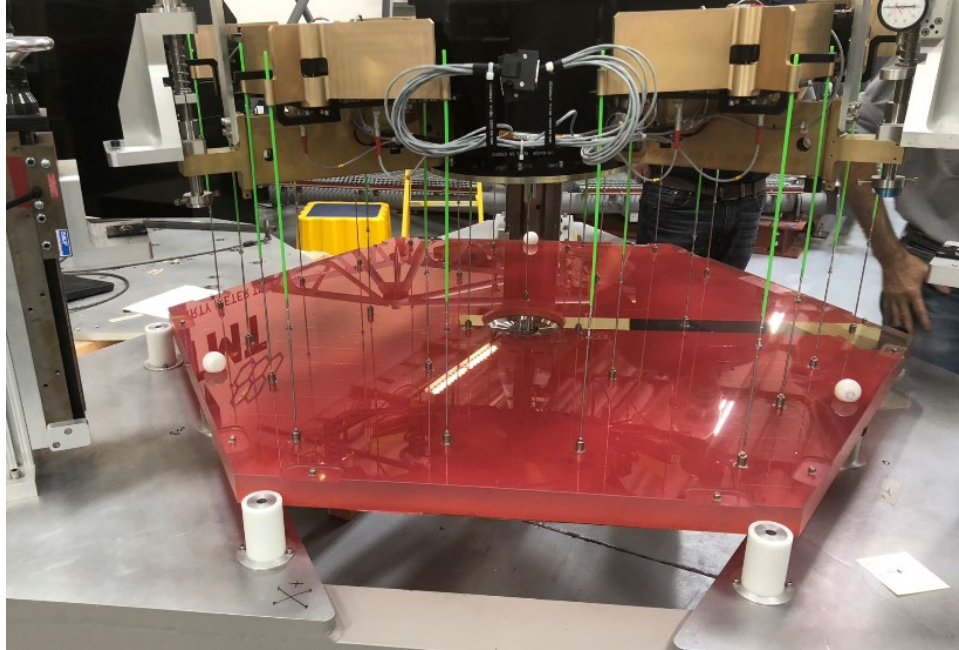


Figure 47 – The green straws fitted to all the mirror rod flexures.

(Initial)	With a person on each slide crank, have the leader call out quarter-turns clockwise to lower the slide and SSA, until the SSA is 4 in. above the segment.
-----------	---

The next step is to ensure the central boss of the lateral guide flexure (attached to the SSA) mates correctly with the central diaphragm studs (on the segment).

At this stage it is important to be aware of the danger of washers getting hung up on the lateral guide flexure as the SSA is lowered. It is strongly recommended to lower the SSA very slowly in this region, by one-quarter turn at a time, until the washers are through the lateral guide flexure. Careful monitoring by a spotter is essential.

(Initial)	Assign a spotter to watch the two short straws on the moving frame hub. As these come closer to the studs in the central diaphragm, they must be guided into place over the studs. This guides the center boss into the central diaphragm bore. Figure 48 shows what the spotter will be watching for.
-----------	--



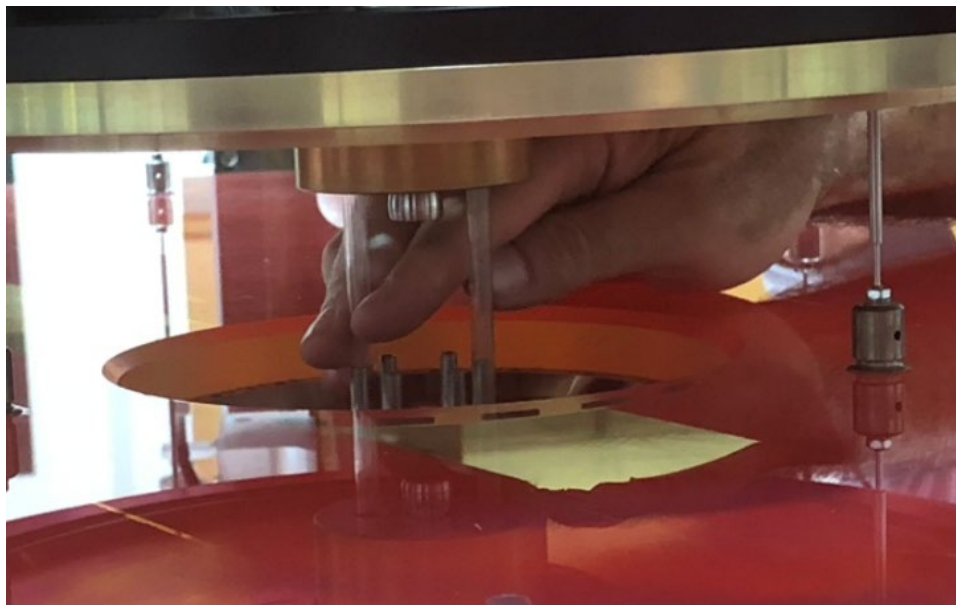


Figure 48 – Using guide straws for central diaphragm stud alignment.

Because the segment is installed on integration table using the hex edges as a guide, the center of the diaphragm can be misaligned with respect to the SSA that is being lowered, because the non-Type-0 hexagonal segments are irregular. The alignment posts may need to be removed to allow the SSA to move over enough so that the SSA can align with the studs on the central diaphragm.

(Initial)	<p>In addition to watching clearance between the straws on the hub of the fixed frame, watch for any binding of the straws on the whiffletree as they move through the holes.</p> <p><i>CAUTION: It should be noted that if the studs or the center boss are misaligned, the diaphragm could become loaded, risking segment damage.</i></p> <p><i>NOTE: Watching the alignment of the diaphragm studs with respect to the moving frame holes from the top may be the only way to monitor alignment. An alignment camera is valuable when monitoring this activity, because access to view the diaphragm studs is difficult.</i></p>
-----------	---

(Initial)	<p>With a person on each slide crank, have a leader call out half-turns clockwise to lower the slide and SSA until ball is ½ in. away from the foot (flat, vee, flat) on the dial indicator brackets.</p>
-----------	---



*Figure 49 – Lowering the SSA towards the segment for final integration.*

(Initial)	Continue to lower the SSA in half-turn increments, until any one of the three dial indicators registers movement.
-----------	---

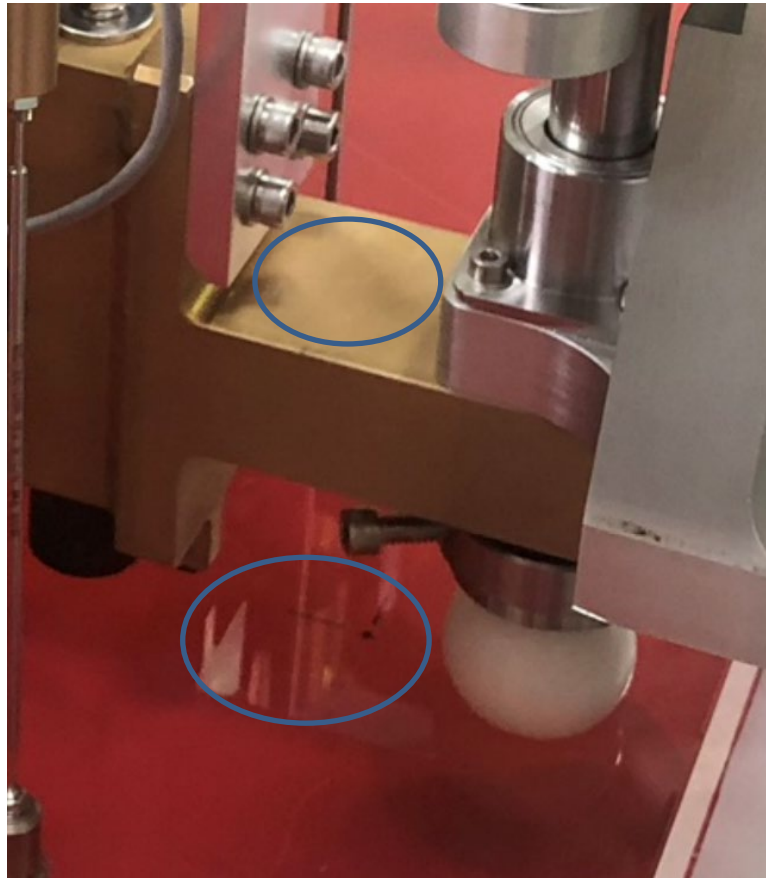
(Initial)	<p>Read the value from the dial indicator that registered the largest value. Record the value below, as it is used again for comparison.</p> <p>Dial indicator reading: _____ mm</p>
-----------	--

(Initial)	Watch the nuts on the Lateral Guide Flexure for clearance with their holes, in three places.
-----------	--

(Initial)	Slowly advance the other two crank arms until the dial indicators match the first moving indicator with the high number (recorded above).
-----------	---



(Initial)	Measure the spacing between the moving frame and the S2 surface using a depth gauge. See Figure 50 below.
-----------	---



*Figure 50 – The measurement spots to confirm the distance between the S2 glass surface and the datum surface on the backside of the moving frame arms.*

(Initial)	Calculate the movement required and individually advance the crank arms in small increments of 0.005 in. until all dial indicators read the required targets.
-----------	---

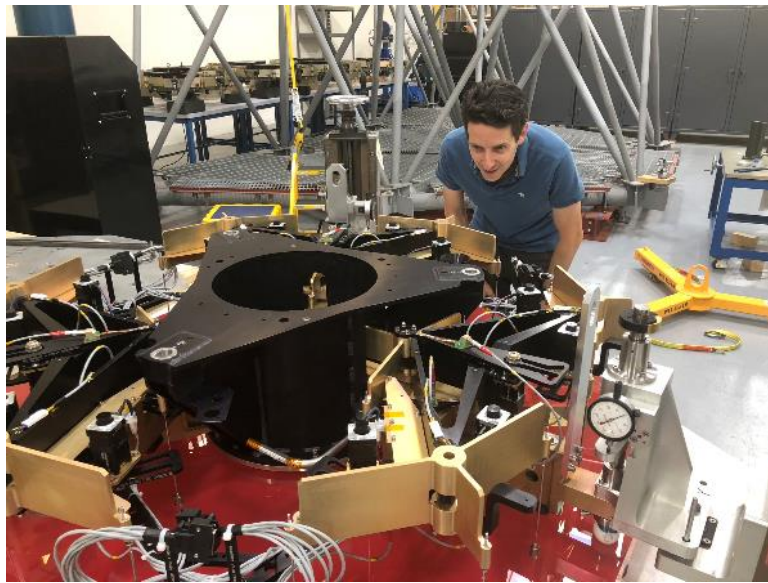
(Initial)	Confirm that the height of the fixed frame relative to the S2 (non-optical) segment surface is correct. The design value is 83.932 mm.
-----------	--

Measured values:	Y arm: _____	mm
	BE arm: _____	
	CF arm: _____	

*NOTE: If the measured value does not match the design value, then drive the arms to the nominal. This can be measured using a depth micrometer fitted with an extension, to measure between these two surfaces. All three stations should measure the same value to within 0.050 mm, and should match the design value to within 0.050 mm.*

**3.10.18 Prepare to connect the SSA to the BMA**

(Initial)	Remove the green straws from the mirror rod flexures.
-----------	---



*Figure 51 – The SSA resting on the segment.*

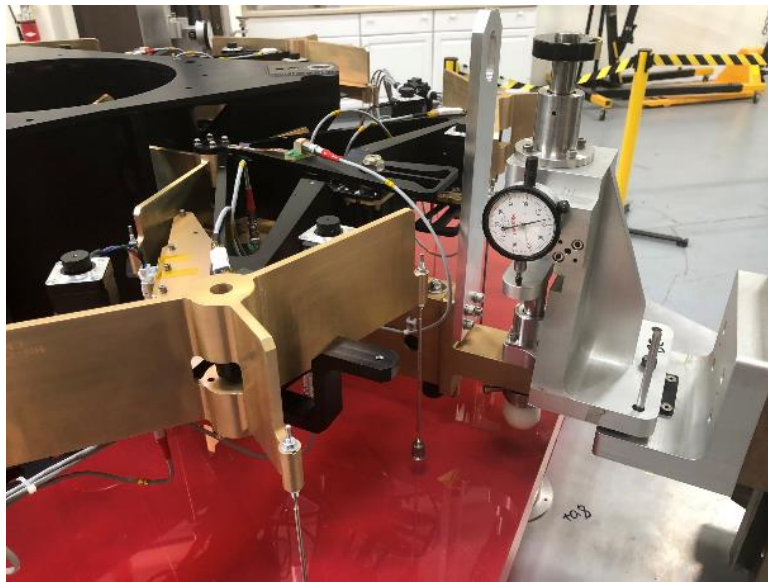
(Initial)	Remove the two straws from the studs of the central diaphragm
-----------	---

(Initial)	Install nuts on the upper end of each mirror rod flexure, loosely.
-----------	--

**3.10.19 Connect the SSA**

(Initial)	Run the lower of the mirror rod flexure nuts up until lightly touching the bottom of the whiffletree triangle, without disturbing the balance of the whiffle tree.
-----------	--

(Initial)	Run the upper nuts (M4s with cone washer) of the mirror flexure down until touching the outer surface of the whiffletree, and torque to $1.0 \pm 0.1$ Nm.
-----------	---



*Figure 52 – All the MRF hardware is tightened.*

(Initial)	Install the hex nuts with the conical washers on the studs of the central diaphragm and torque to $4.7 \pm 0.5$ Nm. Start with an 8 mm magnetic socket and finish with an 8 mm deep socket.
-----------	---

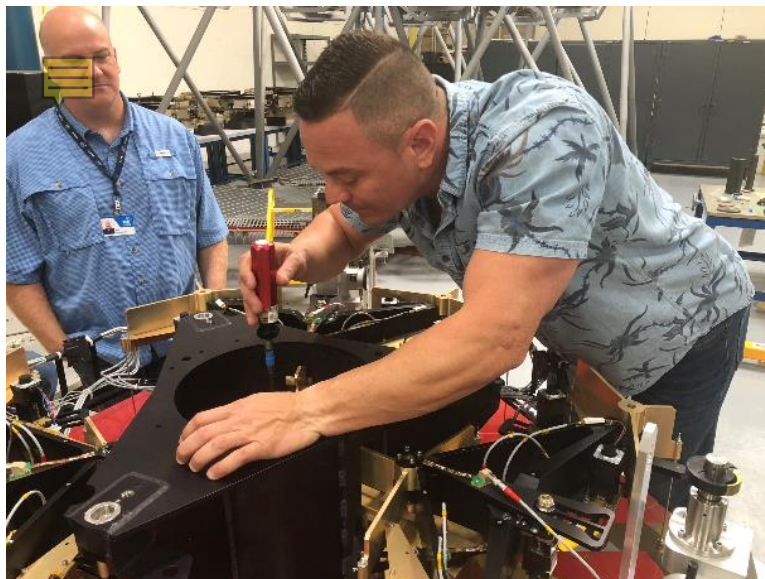


Figure 53 – Tightening the central diaphragm studs.

(Initial)	Offload the full weight of the SSA onto the segment. This is done by slowly moving the three slides down until there is space between the hardened surface of the dial indicator bracket, and the chrome ball.
-----------	--

**3.10.20 Functional Test of the Warping Harness Actuators**

(Initial)	Perform a functional test of the warping harness actuators with the SSA controller. This functional test ensures that the deadband can be found on all actuator motors, and there is $\pm 5$ mm of stroke around the deadband.
-----------	--

**3.10.21 Attach Segment Compensation Weights to the SSA**

For integrated segments that are to be installed into the telescope, it is necessary to attach three compensation weights to the SSA.

Describe how to install compensation weights.



When installing dummy aluminum segments for use in the MSIT, it is not necessary to install compensation weights.

**3.10.22 Stake the mirror rod flexures**

(Initial)	Use 3M 2216 epoxy (T23) to stake the upper two hex nuts on the 27 MRFs.
-----------	---

**3.10.23 Install the tangent restraint on the Y arm of the moving frame**

(Initial)	Prepare the tangential restraint with nuts on each end as shown below.
-----------	--



*Figure 54 – Tangential restraint with nuts fitted at each end.*

(Initial)	Make sure that there is a foam cover protecting the S2 surface during the next steps.
-----------	---

(Initial)	Slide the M4 flat washer and hex nut over the end of the tangential restraint and push towards the M4 end, allowing them to float freely.
-----------	---

(Initial)	Thread the M3 hex nut and place the lock and flat washers over the end.
-----------	---

(Initial)	Slide the M4 threaded end of the tangent restraint through hole moving frame Y arm. Thread the M3 end of the tangent restraint into the clamp, and torque to $1.0 \pm 0.1$ Nm.
-----------	--

(Initial)	Thread the M4 nut by hand finger-tight, snug against the moving frame. Do not torque.
-----------	---

(Initial)	Use the custom 7 mm wrench (see Figure 55 below) to go over tangential restraint arm, and place on the M4 nut.
-----------	--



Figure 55 – Custom 7 mm wrench for use with the tangential restraint fasteners.

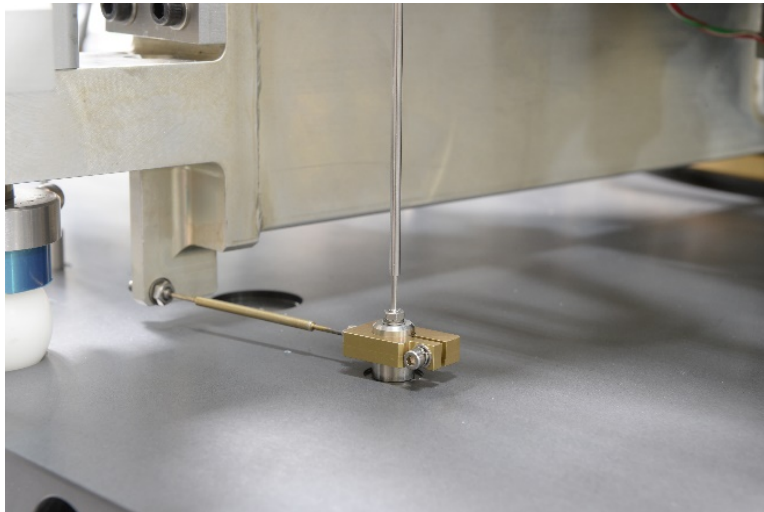
(Initial)	<p>Install the M4 nut with the conical washer on to the M4 threaded end of the tangential restraint and tighten to <math>1.0 \pm 0.1</math> Nm, while restraining the M4 nut on the opposite side of the flange from rotating by using the appropriate tooling. Refer to Figure 56 below.</p> <p><i>CAUTION: No strain should be in the MRF rod. It is very important to perform equal-and-opposite torquing so that the MRF rod is not in tension. Tension in this rod puts astigmatism into the optical surface.</i></p>
-----------	--

(Initial)	Torque the split clamp with a torque wrench set to 1 Nm.
-----------	--





*Figure 56 – Torquing the tangential restraint arm fasteners.*



*Figure 57 – The tangential restraint.*



### 3.10.24 Finish integration

(Initial)	<p>Raise the shaft of each of the dial indicator brackets in turn, and secure it by locking the clamp at the top. See Figure 58 and Figure 59.</p> <p><i>CAUTION: Two person operation!</i></p> <p><i>CAUTION: The spring is very strong and can slip easily. If the spring slips a large load can be put into the segment surface.</i></p>
-----------	---

(Initial)	<p>Add foam protection to the segment S2 surface in the vicinity of the three slides.</p>
-----------	---

(Initial)	<p>Undo nut on the flat/vee/flat to release from shaft of dial indicator bracket.</p> <p><i>CAUTION: There is loose hardware on the flat/vee/flat feet that can drop and damage glass substrate. Take care when removing.</i></p>
-----------	---

(Initial)	<p>Remove the flat/vee/flat feet.</p>
-----------	---------------------------------------

(Initial)	<p>Leave the Delrin balls in place in the cones.</p>
-----------	--



Figure 58 – Removing the collar clamp to release the Delrin balls.

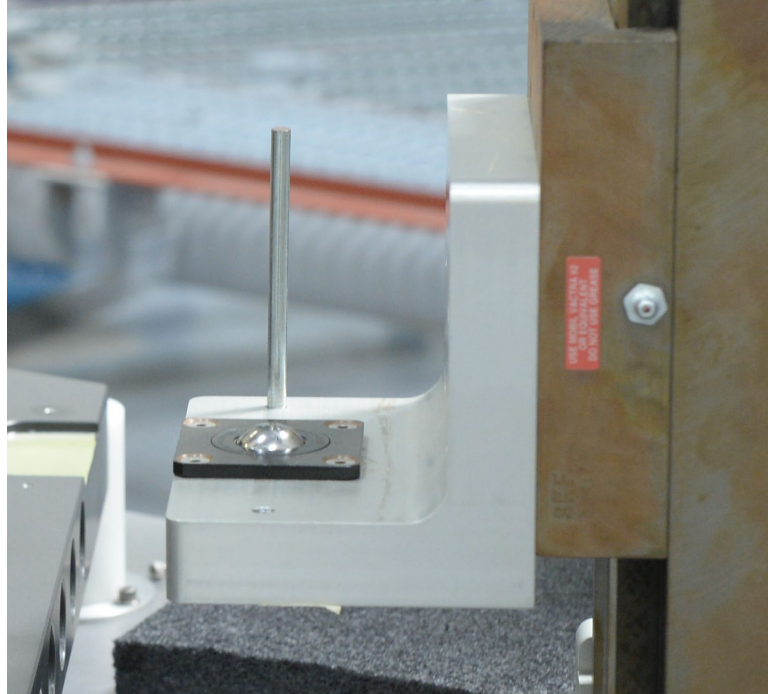
(Initial)	<p>Remove the four 4 mm screws restraining the dial indicator brackets and unbolt them carefully. See Figure 59 below.</p> <p><i>CAUTION: Have a second person as a spotter, and remove the brackets one at a time.</i></p> <p><i>CAUTION: The dial indicator brackets are heavy and unbalanced, and damage to the substrate can occur if these brackets slip or fall during removal. Exercise care.</i></p>
-----------	--



Figure 59 – Unbolting the dial indicator brackets.

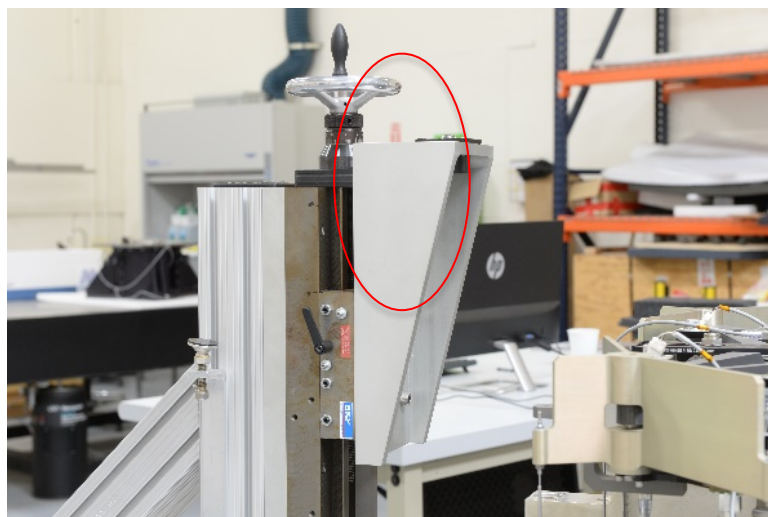
### 3.11 SET THE TOWER CLOCKING

(Initial)	Remove small lifting brackets from the slides (Excelis/Harris part number 944-338) <i>CAUTION: The brackets are heavy and unbalanced with non-captive hardware. Damage to the substrate can occur if these brackets slip or fall during removal. It is recommended that two people remove the brackets.</i>
-----------	--



*Figure 60 – The small lift bracket.*

(Initial)	Install the large lift brackets (944-337) as shown below.
-----------	---



*Figure 61 – The large lift brackets.*

(Initial)	<p>Now, prepare the feet that will be fitted to the alignment shafts later.</p> <p>Collect the cone, vee, and flat feet for the three locations. The cone will be used on BE arm, the vee will be used on Y arm, and the flat will be used on CF arm. Remove the spacers from all feet. The flat for the CF arm is marked 'BE'.</p> <p><i>CAUTION: The feet will not fit on the arms if the spacers are installed.</i></p>
-----------	--

(Initial)	<p>Raise the integration table slides to the 'A' position.</p>
-----------	--

(Initial)	<p>Place the three 1.5 in dia. Delrin balls into the three cones on the segment.</p>
-----------	--

(Initial)	<p>Verify that the alignment pins (see Figure 62) are installed in the alignment plate in three places.</p>
-----------	---



*Figure 62 – An alignment pin.*

(Initial)	<p>Using the 14 in. long 5 mm Allen key tool (T29), loosen the screws that secure the tower to the guide flexure, and ensure all associated washers are loose.</p>
-----------	--

(Initial)	<p>Unlock the central tower from the moving frame by releasing the three tower locking levers – see Figure 63 below.</p>
-----------	--



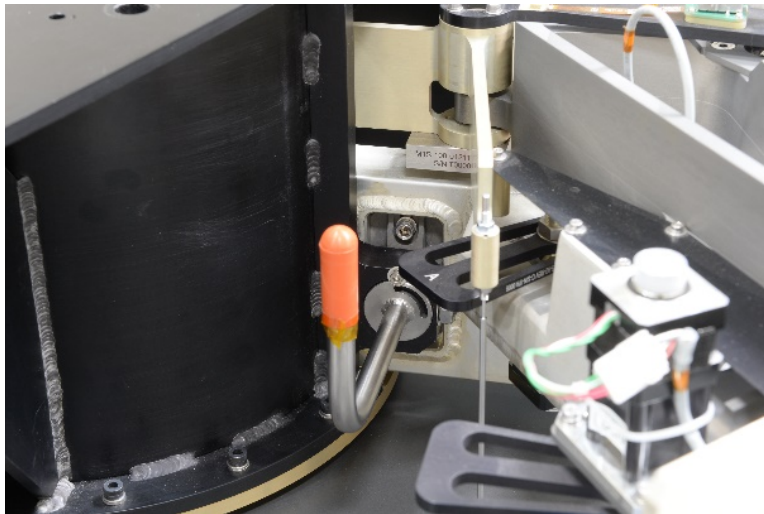


Figure 63 – One of the tower locking levers.

(Initial)	Install the spacer pins (Figure 64) into the alignment plate. Verify that the spacer pins are ‘free moving’.
-----------	--

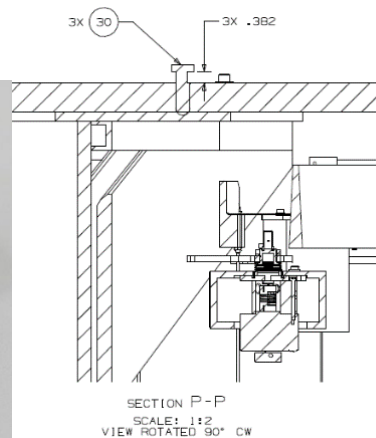
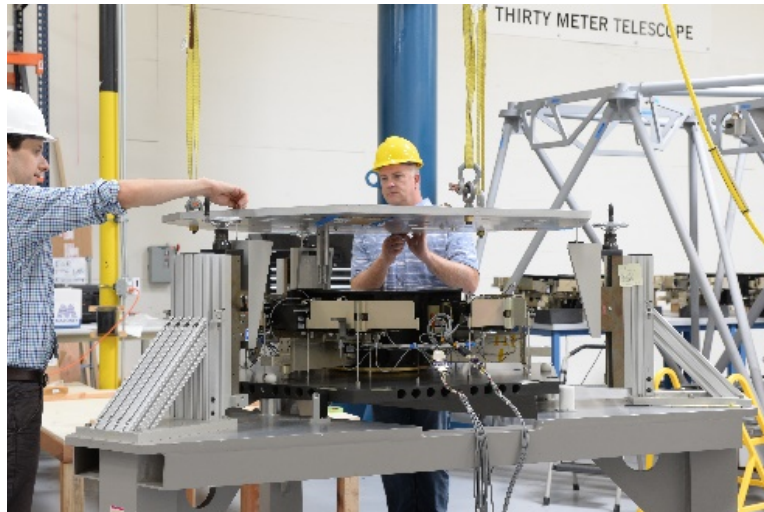


Figure 64 – Spacer pins.

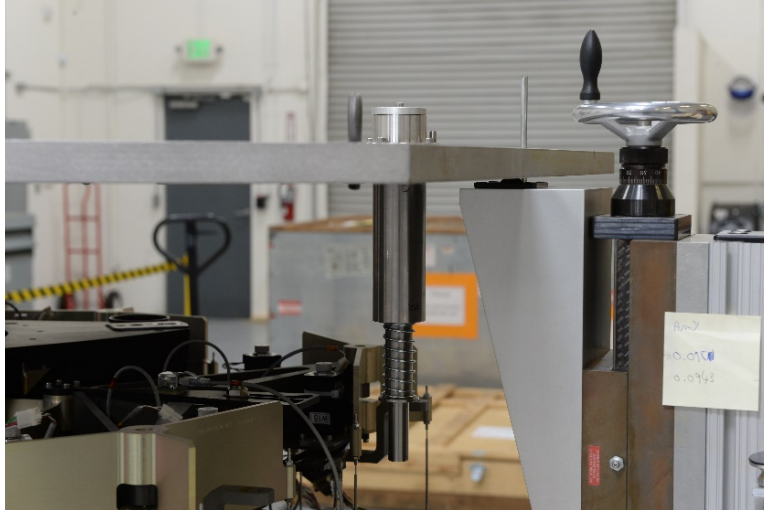
(Initial)	Attach the alignment plate to the overhead crane.
-----------	---



*Figure 65 – The alignment plate attached to the crane.*

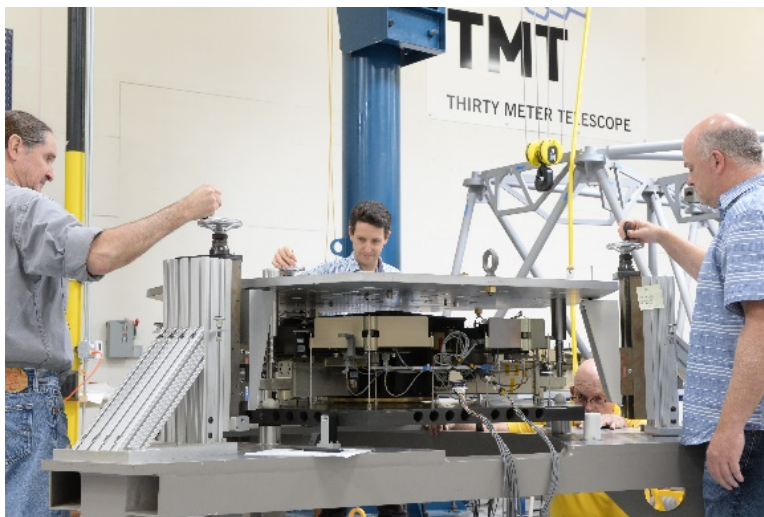
(Initial)	Using the overhead crane, lift and position the alignment plate over the tower.
(Initial)	Lower alignment plate so that the three guide pins can be installed and engaged on alignment plate.
(Initial)	Lower the alignment plate onto the large lift brackets, ensuring that the guide pins are in the correct location.
(Initial)	Install the tower alignment shaft assembly into the alignment plate, as shown in pg. 8 of DWG 944-332.





*Figure 66 – The shaft assembly installed on the alignment plate.*

(Initial)	Using the hand cranks, lower the alignment plate until the tower alignment shafts pass through the moving frame and are exposed enough so that the mount shaft ends can be installed.
-----------	---

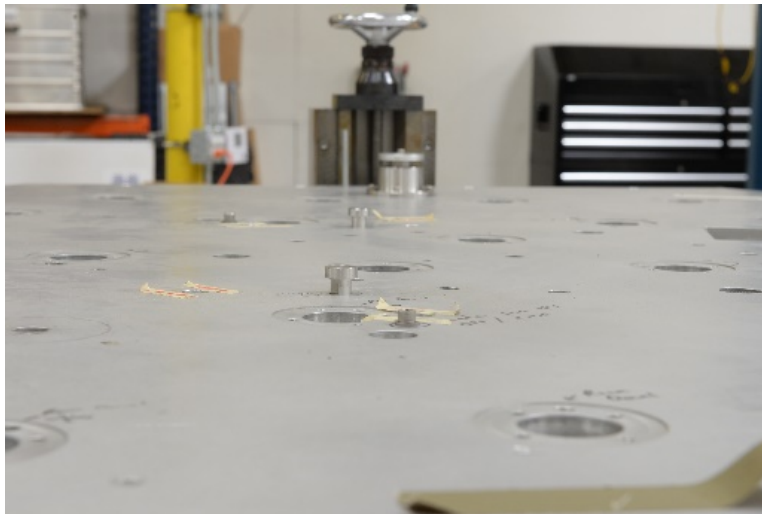


*Figure 67 – Lowering the alignment plate into position.*

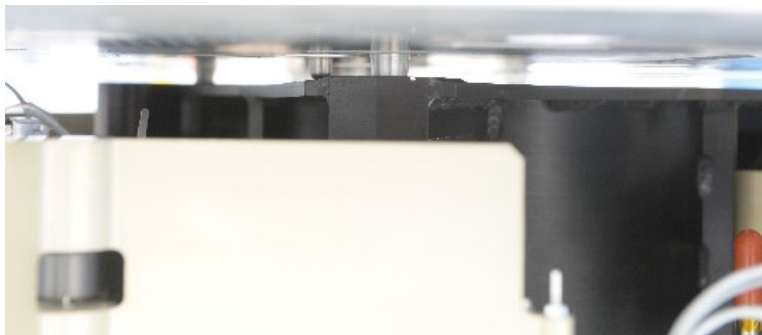
(Initial)	Install foam pads near shaft ends.
-----------	------------------------------------

(Initial)	<p>Install the mount shaft ends onto the tower alignment shafts.</p> <p><i>CAUTION: Two-person operation!</i></p> <p><i>CAUTION: The spring is very strong and can slip easily. If the spring slips a large load can be put into the segment surface. Also, the feet have loose hardware that can come free and damage the segment surface.</i></p>
-----------	---

(Initial)	<p>Using the hand cranks, lower the alignment plate until the spacer pins rise through the alignment plate, and the notches in the spacer pins are flush with the alignment plate. Verify the alignment plate is level by measuring the end of the tower alignment shaft that is exposed above it.</p>
-----------	--



*Figure 68 – Spacer pins rising through the surface of the alignment plate.*



*Figure 69 – The alignment plate pushing the spacer pin up.*

(Initial)	Turn the three hand cranks 2 mm each to raise the alignment plate. The top of the shaft assembly can be measured to confirm that the plate has indeed been raised 2 mm.
-----------	---

(Initial)	Remove the alignment pins so that alignment plate can float, to provide adequate clearance for the mounting holes in the next step.
-----------	---



*Figure 70 – Removing the alignment pins.*

(Initial)	Insert the M12 screws into the clearance holes near the alignment pins.
-----------	---

(Initial)	Tighten the M12 screws to lift the tower, until the tower is snug to the alignment plate. Tighten all three screws simultaneously.
-----------	--

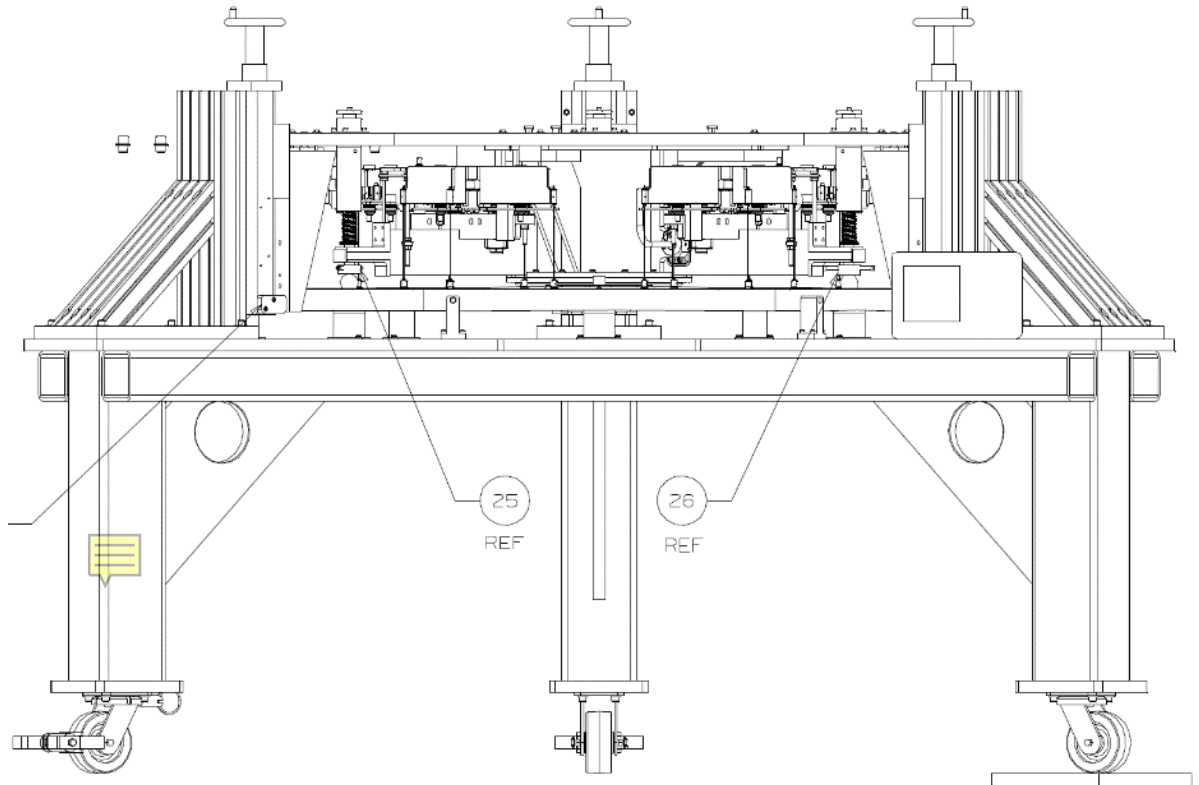


Figure 71 – Tower alignment tooling.

(Initial)	<p>Reach through the alignment plate with an extended driver, and torque the screws to the guide flexure. Take care when reaching through the alignment plate and the moving frame, as there are sensitive wire bundles in this area.</p> <p>Torque each of the twelve bolts to 8.5 Nm.</p> <p><i>NOTE: This is a two-person operation – one person will drive the bolts while the other guides the bolt driver.</i></p>
-----------	--

(Initial)	<p>Unscrew the M12 bolts to lower the tower.</p>
-----------	--

(Initial)	<p>Using the hand cranks, raise the alignment plate to release the spring pressure on the three Delrin balls.</p>
-----------	---

(Initial)	<p>Remove the mount shaft ends.</p> <p><i>NOTE: Two-person operation!</i></p> <p><i>CAUTION: The spring is very strong and can slip easily. If the spring slips a large load can be put into the segment surface. Also the feet have loose hardware that can come free and damage the segment surface.</i></p>
-----------	--

(Initial)	<p>Install the alignment guides onto the lifting brackets.</p>
-----------	--

(Initial)	<p>Using the hand cranks, raise the alignment plate so that it is clear of tower interface. Ensure the alignment shaft assemblies are no longer engaged in moving frame.</p>
-----------	--

(Initial)	<p>Remove the alignment plate with the crane.</p>
-----------	---

(Initial)	<p>Lock the moving frame using the three tower locking levers.</p>
-----------	--

### 3.12 MEASURE ASSEMBLY WITH CMM OR ROAMER ARM

Establish Datum from Tower Interface,

Measure Hex Perimeter

Measure PSA Coordinate System

Measure moving frame to substrate distance

Add some photos and general description of the measurement performed

Notes from Alastair on 3/29/19:

Lock the central tower to the moving frame

Page 9, section 3.2 : Hard hats should be worn using chin-straps as a mandatory requirement for safety of the glass

Page 10 : Under the list of "gather the following tools", are we assuming the "dial indicator end pieces" are part of the integration table? I would have said they are not.

A second question - is there any type of calibration needed on the dial indicators before they're installed?

Page 12: Sentence that reads "Keep some as the segment rests on three support pads" looks like it's been cut off.